

LOWRANCE®

www.lowrance.com

Pub. 988-0151-451



X510C & X515C DF

Fish-finding and Depth Sounding Sonars

Operation Instructions

**Copyright © 2006 Lowrance Electronics, Inc.
All rights reserved.**

No part of this manual may be copied, reproduced, republished, transmitted or distributed for any purpose, without prior written consent of Lowrance Electronics. **Any unauthorized commercial distribution of this manual is strictly prohibited.**

Lowrance® is a registered trademark of Lowrance Electronics, Inc.

Lowrance Electronics may find it necessary to change or end our policies, regulations, and special offers at any time. We reserve the right to do so without notice. All features and specifications subject to change without notice. All screens in this manual are simulated. On the cover: X515cDF shown.

**For free owner's manuals and other information,
visit our web site:
www.lowrance.com**

Lowrance Electronics Inc.
12000 E. Skelly Dr.
Tulsa, OK USA 74128-2486
Printed in USA.

Table of Contents

Section 1: Read Me First!	1
Capabilities and Specifications: X-510c & X-515cDF	2
How Sonar Works.....	3
How to use this manual: typographical conventions	4
Section 2: Installation & Accessories	7
Preparations	7
Transducer Installation	7
Single-frequency transom installations	8
Dual-frequency transom installations	8
Single-frequency trolling motor installations	8
Shoot-through hull installations	8
Selecting a Transducer Location	8
How low should you go?	9
Shoot-thru-hull vs. Transom Mounting	10
Transom Transducer Assembly And Mounting	11
Trolling Motor Bracket Installation (single-frequency only)	17
Transducer Orientation and Fish Arches	17
Shoot-Thru-Hull Preparation	18
Hulls With Flootation Materials	18
Testing Determines Best Location	19
Shoot-thru-hull Installation	21
Speed/Temperature Sensors	22
Optional Speed Sensor Installation	22
Power Connections	24
Powering Your Display Unit	25
Power Diagram A	27
Power Diagram B	28
Powering a NMEA 2000 Network Bus	28
NMEA 0183 Cable Connections	29
Mounting the Unit: Bracket, In-Dash or Portable	29
Other Accessories	33
Cleaning Towel	33
Face Cover	33
Section 3: Basic Sonar Operation	35
Keyboard.....	35
Power/lights on and off	36
Menus.....	36
Main Menu.....	36
Sonar Menu.....	38
Pages	39
Basic Sonar Quick Reference	43
Sonar Operations	44

Fish Symbols vs. Full Sonar Chart	46
Other Free Training Aids	47
Section 4: Sonar Options & Other Features.....	49
ASP™ (Advanced Signal Processing)	49
Alarms	50
Depth Alarms	50
Zone Alarm	51
Fish Alarm	52
Brightness	53
Calibrate Speed	53
Chart Speed	54
Colorline.....	55
Contrast	56
Depth Cursor	56
Depth Range - Automatic	56
Depth Range - Manual.....	57
Depth Range - Upper and Lower Limits	57
FasTrack™	59
Fish I.D.™ (Fish Symbols & Depths)	60
FishTrack™	61
Frequency (Change Transducer Frequency) (X-515cDF only)	62
HyperScroll™	63
Noise Rejection	63
Overlay Data	63
Ping Speed & HyperScroll™	65
Pop-up Help	67
Reset Options.....	67
Reset Water Distance.....	68
Screen Contrast and Brightness	68
Sensitivity & Auto Sensitivity.....	69
Automatic Sensitivity	70
Set Keel Offset.....	71
Set Language.....	72
Software Version Information	73
Sonar Chart Mode	73
Sonar Chart Display Options	74
Full Sonar Chart	74
Split Zoom Sonar Chart	75
Split Frequency Sonar Chart (X-515cDF only)	75
Digital Data/Chart	76
Customizing the Digital Data/Chart Screen	77
Flasher	78
Sonar with Custom Gauges	79

Radar.....	81
Sonar Simulator	81
Stop Chart.....	82
Surface Clarity	82
Transducer Type (X-515cDF only)	83
Transparency.....	84
Units of Measure	85
Upper and Lower Limits.....	86
Zoom & Zoom Bar.....	86
Zoom Pan	87
Section 5: NMEA 2000 Menu.....	89
NMEA 2000 Menu.....	89
Bus Setup.....	89
Engine & Tank Configuration.....	90
Tank Select	91
Tank Size	91
Set Configuration button	91
Device Configuration Menu.....	92
Device Information and Device Data	92
Fuel Management Menu.....	93
Tank Location	93
Fuel Added.....	93
Add Fuel.....	94
Fill Tank.....	94
Adding Fuel to Tank	94
Engine Operations.....	94
Engine Select	94
NMEA 2000 Alarms	95
To set NMEA 2000 Alarm:.....	96
Waypoint Sharing	96
Backlight Synchronization	96
Configuring EP Sensors.....	97
EP-35 Temperature Configuration	97
Advanced Options menu	97
Instance.....	98
Restore Defaults	98
To restore default settings	98
EP-10 Fuel Flow Configuration.....	98
Advanced Options menu	99
Instance.....	99
Restore Defaults	99
EP-15 Fluid Level Configuration	100
Advanced Options menu	102

Instance	102
Restore Defaults	102
To restore default settings:	102
Suzuki Engine Interface Configuration	103
Advanced Options menu	104
Instance	104
Restore Defaults	104
Calibrating EP Sensors	105
EP-10 Fuel Flow Calibration	105
EP-15 Fluid Level Calibration	106
2-Point Calibration	106
3-Point Calibration	107
5-Point Calibration	108
Fuel Flow Calibration in a Suzuki Engine Interface	109
Engine Trim Calibration	110
Reset Trim Calibration	111
Bennett Trim Tabs Calibration	111
Section 6: Sonar Troubleshooting	113

NOTICE!

The storage and operation temperature range for your unit is from -20 degrees to +167 degrees Fahrenheit (-28 degrees to +75 degrees Celsius). *Extended storage or operation in temperatures higher or lower than specified will damage the liquid crystal display in your unit. This type of damage is not covered by the warranty.* For more information, contact the factory's Customer Service Department; phone numbers are listed on the last page of the manual.

Section 1: Read Me First!

How this manual can get you out on the water, fast!

Welcome to the exciting world of digital sonar! We know you're anxious to begin finding fish, but we have a favor to ask. Before you grab your unit and begin installing it, please give us a moment or two to explain how our manual can help you get the best performance from your compact, wide-screen, fish finder.

First, we want to thank you for buying a Lowrance sonar. Whether you're a first time user or a professional fisherman, you'll discover that your unit is easy to use, yet capable of handling demanding sonar tasks. You won't find another sonar unit with this much power and this many features for this price!

Our goal for this book is to get you on the water fast, with a minimum of fuss. Like you, we'd rather spend more time boating or fishing and less time reading the manual!

So, we designed our book so that you *don't* have to read the *whole thing* from front to back for the information you want. At the start (or end) of each segment, we'll tell you what content is coming up next. If it's a concept you're already familiar with, we'll show you how and where to skip ahead for the next important topic. We've also made it easy to look up any tips you may need from time to time. Here's how:

The manual is organized into 6 sections. This first section is an introduction to the sonar unit. It tells you the basics you need to know before you can make the unit look below the surface to find some fish.

Section 2 will help you install your unit and the transducer. We'll also tell you about some of the available accessories.

Section 3 covers *Basic Sonar Operation*. It will show you how easy it is to run your sonar, right out of the box. This section features a one-page Sonar Quick Reference. **(If you've already jumped ahead and figured out how to install the unit yourself, and you just *can't* wait any longer, turn to the Quick Reference on page 43 and head for the water with your sonar unit!)**

After you've gained some experience with your sonar, you'll want to check out Section 4, which discusses more advanced *Sonar Options and Other Features*.

When you come to a sonar menu command on the unit's screen, you can look it up in the manual by skimming over the table of contents or index, just flipping through Section 3 or scanning through the sonar options in Section 4.

If you're having difficulty with your sonar, you can find an answer to the most common problems in Section 5, *Sonar Troubleshooting*.

Finally, in Section 6, we offer *Supplemental Material*, including a list of warranty and customer service information.

Now, if you're into the fine details, glance over the next segment on specifications to see just how much sonar power your unit contains. It's important to *us* (and our power users), but, if *you* don't care how many watts of power the unit has, skip ahead to important information on how sonar works, on page 3.

Capabilities and Specifications: X-510c & X-515cDF

General

Display: 5.0" (12.7 cm) diagonal high color contrast Film SuperTwist; programmable to viewing preference.

Resolution: 480 pixel x 480 pixel resolution ; 230,400 total pixels.

Backlighting: **X-510c, X-515cDF**
White LED backlit screen and keypad.

Input power: 10 to 15 volts DC.

Case size: 5.4" H x 6.9" W x 3.4" D (13.8 x 17.6 x 8.6 cm); sealed and waterproof; suitable for saltwater use.

Back-up memory:..... Built-in memory stores sonar records for decades.

Languages: 10; menu languages selectable by user.

Sonar

Frequency: 50/200 kHz for X-515cDF; 200 kHz for X-510c.

Transducers:..... A dual-frequency Skimmer® transducer with built-in temperature sensor is packed with the X-515cDF. It has 35°/12° cone angles. A single-frequency with built-in temperature sensor is packed with the X-510c. It has a 20° cone angle. Transducers operate at speeds up to 70 mph (61 kts).

Transmitter:.....**X-515cDF:**
4,000 watts peak-to-peak/500 watts RMS.
X-510c:
2,400 watts peak-to-peak/300 watts RMS.

Sonar sounding

depth capability:.....**X-515cCDF:** 2,500 feet (762 meters).
X-510c: 800 feet (244 meters).
Actual capability depends on transducer configuration and installation, bottom composition and water conditions. All sonar units typically read deeper in fresh water than in salt water.

Depth display: Continuous display.

Audible alarms:..... Deep/shallow/fish/zone.

Automatic ranging: Yes, with instant screen updates.

Auto bottom track: Yes.

Zoom bottom track:..... Yes.

Split-screen zoom: Yes.

Surface water temp: Yes.

Speed/distance log: Optional (requires optional speed sensor).

NOTICE!

The storage temperature range for your unit is from -4 degrees to +167 degrees Fahrenheit (-20 degrees to +75 degrees Celsius). *Extended storage in temperatures higher or lower than specified will damage the liquid crystal display in your unit. This type of damage is not covered by the warranty.* For more information, contact the factory's Customer Service Department; phone numbers are listed on the last page.

How Sonar Works

Sonar has been around since the 1940s, so if you already know how it works, skip ahead to the next segment on the typographical conventions used in this manual. But, if you've never owned a sonar fish finder, this segment will tell you the under water basics.

Sonar is an abbreviation for Sound Navigation and Ranging, a technology developed during World War II for tracking enemy submarines. (Lowrance developed the world's *first* transistorized *sportfishing* sonar in 1957.) A sonar consists of a transmitter, transducer, receiver and display. In simple terms, here's how it finds the bottom, or the fish:

The transmitter emits an electrical impulse, which the transducer converts into a sound wave and sends into the water. (The sound frequency can't be heard by humans or fish.) The sound wave strikes an object (fish, structure, bottom) and bounces back to the transducer, which converts the sound back into an electrical signal.

The receiver amplifies this return signal, or echo, and sends it to the display, where an image of the object appears on the scrolling sonar chart. The sonar's microprocessor calculates the time lapse between the transmitted signal and echo return to determine the distance to the object. The whole process repeats itself several times each second.

How to use this manual: typographical conventions

Many instructions are listed as numbered steps. The keypad and arrow "keystrokes" appear as boldface type. So, if you're in a real hurry (or just need a reminder), you can skim the instructions and pick out what menu command to use by finding the boldface command text. The following paragraphs explain how to interpret the text formatting for those commands and other instructions:

Arrow Keys

The arrow keys control a horizontal line depth cursor on the sonar screen. The arrow keys also help you move around the menus so you can execute different commands. They are represented by symbols like these, which denote the down arrow key, the up arrow, the left arrow and the right arrow: ↓ ↑ ← →.

Keyboard

The other keys perform a variety of functions. When the text refers to a key to press, the key is shown in bold, sans serif type. For example, the "Enter/Icons" key is shown as **ENT** and the "Menu" key is shown as **MENU**.

Menu Commands

A menu command or a menu option will appear in small capital letters, in a bold sans serif type like this: **DEPTH CURSOR**. These indicate that you are to select this command or option from a menu or take an action of some kind with the menu item. Text that you may need to enter or file names you need to select are shown in italic type, such as *data type*.

Instructions = Menu Sequences

Most functions you perform with the sonar unit are described as a sequence of key strokes and selecting menu commands. We've written them in a condensed manner for quick and easy reading.

For example, instructions for turning on the Fish ID™ feature would look like this:

1. From the Sonar Page, press **MENU** | ↓ to **SONAR FEATURES** | **ENT**.
2. Press → to **FISH SYMBOLS** | **ENT** | **EXIT** | **EXIT**.

Translated into complete English, step 1 above would mean: "Start on the Sonar Page. Press the Menu key then repeatedly press (or press and hold) the down arrow key to scroll down the menu and select (highlight) the Sonar Features menu command. Then press the Enter key."

Step 2 would mean: "Press the right arrow key to select (highlight) the Fish ID symbols command. Next, press the Enter key, then press the Exit key twice."

Notes

Section 2:

Installation & Accessories

Preparations

You can install the sonar system in some other order if you prefer, but we recommend this installation sequence:

Caution:

You should read over this entire installation section before drilling any holes in your vessel!

1. Determine the approximate location for the sonar unit, so you can plan how and where to route the cables for the transducer and power. This will help you make sure you have enough cable length for the desired configuration.
2. Determine the approximate location for the transducer and its cable route.
3. Determine the location of your battery or other power connection, along with the power cable route.
4. Install the transducer and route the transducer cable to the sonar unit.
5. Install the power cable and route it to the sonar unit.
6. Mount the sonar unit.

Transducer Installation

These instructions will help you install your Skimmer[®] transducer on a transom, on a trolling motor or inside a hull. These instructions cover both single- and dual-frequency Skimmer transducers. Please read all instructions before proceeding with any installation.

The smaller single-frequency Skimmers typically use a one-piece, stainless steel mounting bracket. The larger dual-frequency Skimmers typically use a two-piece, plastic mounting bracket. The trolling motor mount uses a one-piece plastic bracket with an adjustable strap.

These are all "kick-up" mounting brackets. They help prevent damage if the transducer strikes an object while the boat is moving. If the transducer does "kick-up," the bracket can easily be pushed back into place without tools.

Read these instructions carefully *before* attempting the installation. Determine which of the mounting positions is right for your boat. ***Remember, the transducer installation is the most critical part of a sonar installation.***

NOTE:

The following installation types also call for these recommended tools and required supplies that you must provide (supplies listed here are *not* included):

Single-frequency transom installations

Tools include: two adjustable wrenches, drill, #29 (0.136") drill bit, flat-head screwdriver. Supplies: *high quality, marine grade* above- or below-waterline sealant/adhesive compound.

Dual-frequency transom installations

Tools: two adjustable wrenches, drill, #20 (0.161") drill bit, flat-head screwdriver. Supplies: four, 1" long, #12 stainless steel slotted wood screws, *high quality, marine grade* above- or below-waterline sealant/adhesive compound.

Single-frequency trolling motor installations

Tools: two adjustable wrenches, flat-head screwdriver. Supplies: plastic cable ties.

Shoot-through hull installations

Tools: these will vary depending on your hull's composition. Consult your boat dealer or manufacturer. Other tools are a wooden craft stick or similar tool for stirring and applying epoxy, and a paper plate or piece of cardboard to mix the epoxy on. Supplies: rubbing alcohol, 100 grit sandpaper, specially formulated epoxy adhesive available from LEI (see ordering information on the inside back cover). A sandwich hull also requires polyester resin.

Selecting a Transducer Location

1. The location must be in the water at all times, at all operating speeds.
2. The transducer must be placed in a location that has a *smooth flow* of water at all times. If the transducer is not placed in a smooth flow of water, interference caused by bubbles and turbulence will show on the sonar's display in the form of random lines or dots whenever the boat is moving.

NOTE:

Some aluminum boats with strakes or ribs on the outside of the hull create large amounts of turbulence at high speed. These boats typically have large outboard motors capable of propelling the boat at speeds faster than 35 mph. Typically, a good transom location on aluminum boats is between the ribs closest to the engine.

3. The transducer should be installed with its face pointing straight down, if possible. *For shoot-thru applications:* Many popular fishing

boat hulls have a flat keel pad that offers a good mounting surface. On vee hulls, try to place the transducer where the deadrise is 10° or less.

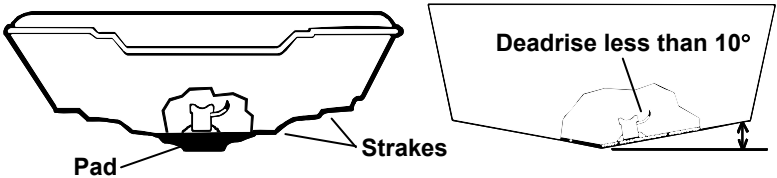

Left, vee pad hull; right, vee hull. A pod style transducer is shown here, but the principle is the same for Skimmers inside a hull.

4. If the transducer is mounted on the transom, make sure it doesn't interfere with the trailer or hauling of the boat. Also, don't mount it closer than approximately one foot from the engine's lower unit. This will prevent cavitation (bubble) interference with propeller operation.
5. If possible, route the transducer cable away from other wiring on the boat. Electrical noise from engine wiring, bilge pumps and aerators can be displayed on the sonar's screen. Use caution when routing the transducer cable around these wires.

CAUTION: Clamp the transducer cable to transom near the transducer. This will help prevent the transducer from entering the boat if it is knocked off at high speed.

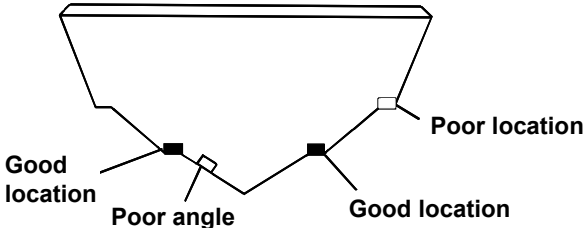
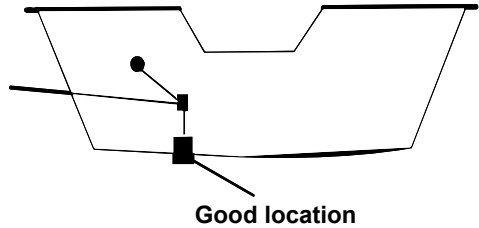

Good and poor transducer locations.

How low should you go?

For most situations, you should install your Skimmer transducer so that its centerline is level with the bottom of the boat hull. This will usually give you the best combination of smooth water flow and protection from bangs and bumps.

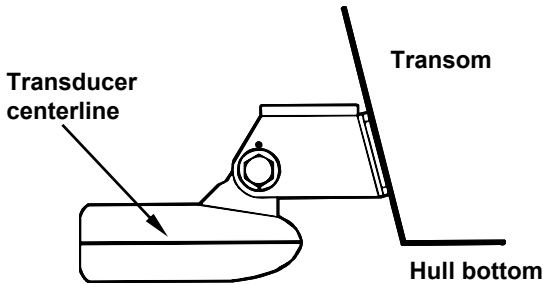

Align transducer centerline with hull bottom.

However, there are times when you may need to adjust the transducer slightly higher or lower. (The slots in the mounting brackets allow you to loosen the screws and slide the transducer up or down.) If you frequently lose bottom signal lock while running at high speed, the transducer may be coming out of the water as you cross waves or wakes. Move the transducer a little lower to help prevent this.

If you cruise or fish around lots of structure and cover, your transducer may be frequently kicking up from object strikes. If you wish, you may move the transducer a little higher for more protection.

There are two extremes you should avoid. Never let the edge of the mounting bracket extend below the bottom of the hull. Never let the bottom – the face – of the transducer rise above the bottom of the hull.

Shoot-thru-hull vs. Transom Mounting

In a shoot-thru-hull installation, the transducer is bonded to the *inside* of the hull with epoxy. The sonar "ping" signal actually passes through the hull and into the water. This differs from a bolt-thru-hull installation (often called simply "thru-hull"). In that case, a hole is cut in the hull and a specially designed transducer is mounted *through* the hull with a threaded shaft and nut. This puts the transducer in direct contact with the water.

Typically, shoot-thru-hull installations give excellent high speed operation and good to excellent depth capability. There is no possibility of transducer damage from floating objects, as there is with a transom-mounted transducer. A transducer mounted inside the hull can't be knocked off when docking or loading on a trailer.

However, the shoot-thru-hull installation does have its drawbacks. First, some loss of sensitivity does occur, even on the best hulls. This varies from hull to hull, even from different installations on the same hull. This is caused by differences in hull lay-up and construction.

Second, the transducer angle cannot be adjusted for the best fish arches on your sonar display. (This is not an issue for flasher-style

sonars.) Lack of angle adjustment can be particularly troublesome on hulls that sit with the bow high when at rest or at slow trolling speeds. Third, a transducer **CAN NOT** shoot through wood and metal hulls. Those hulls require either a transom mount or a thru-hull installation.

Fourth, if your Skimmer transducer has a built in temp sensor, it will only show the temperature of the bilge, not the water surface temp.

Follow the testing procedures listed in the shoot-thru-hull installation section at the end of this lesson to determine if you can satisfactorily shoot through the hull.

Transom Transducer Assembly And Mounting

The best way to install these transducers is to loosely assemble all of the parts first, place the transducer's bracket against the transom and see if you can move the transducer so that it's parallel with the ground.

The following instructions sometimes vary depending on the mounting bracket that came with your transducer. Single-frequency Skimmers come with a one-piece stainless steel bracket, while dual-frequency Skimmers come with a two-piece plastic mounting bracket. Use the set of instructions that fits your model.

1. Assembling the bracket.

A. One-piece bracket: Press the two small plastic ratchets into the sides of the metal bracket as shown in the following illustration. Notice there are letters molded into each ratchet. Place each ratchet into the bracket with the letter "A" aligned with the dot stamped into the metal bracket. This position sets the transducer's coarse angle adjustment for a 14° transom. Most outboard and stern-drive transoms have a 14° angle.

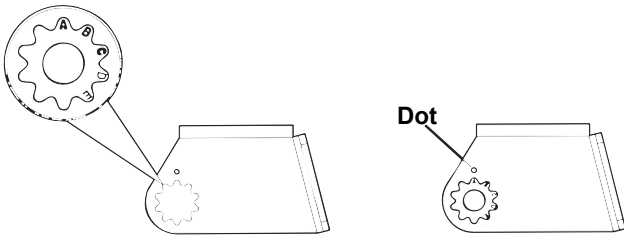

Align plastic ratchets in bracket.

B. Two-piece bracket: Locate the four plastic ratchets in the transducer's hardware package. Press two ratchets into the sides of the plastic bracket and two on either side of the transducer as shown in the following illustrations. Notice there are letters molded into each ratchet.

Place the ratchets into the bracket with the letter "A" aligned with the

alignment mark molded into the bracket. Place the ratchets onto the transducer with the letter "A" aligned with the 12 o'clock position on the transducer stem. These positions set the transducer's coarse angle adjustment for a 14° transom. Most outboard and stern-drive transoms have a 14° angle.

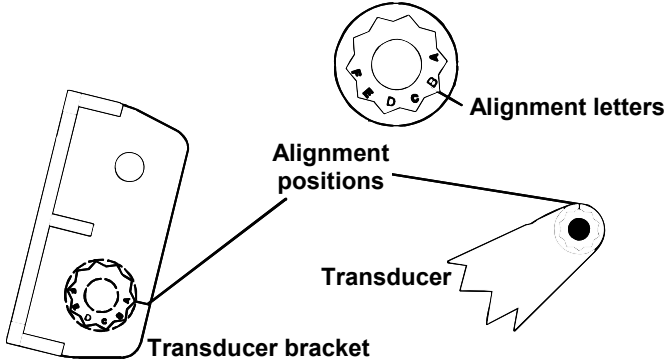

Insert and align ratchets.

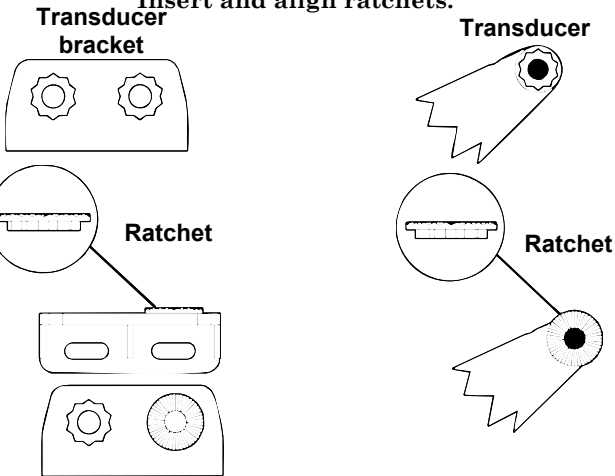

Add ratchets to bracket and transducer.

2. Aligning the transducer on the transom.

A. One-piece bracket: Slide the transducer between the two ratchets. Temporarily slide the bolt through the transducer assembly and hold it against the transom. Looking at the transducer from the side, check to see if it will adjust so that its face is parallel to the ground. If it does, then the "A" position is correct for your hull. If the transducer's face isn't parallel with the ground, remove the transducer and ratchets from the bracket.

Place the ratchets into the holes in the bracket with the letter "B" aligned with the dot stamped in the bracket.

Reassemble the transducer and bracket and place them against the transom. Again, check to see if you can move the transducer so it's parallel with the ground. If you can, then go to step 3A. If it doesn't, repeat step 2A, but use a different alignment letter until you can place the transducer on the transom correctly.

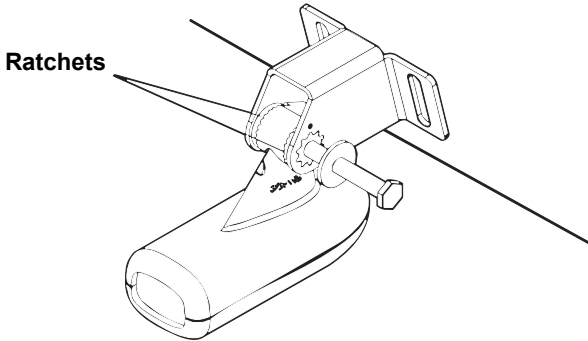

Insert bolt and check transducer position on transom.

B. Two-piece bracket: Assemble the transducer and bracket as shown in the following figure. Temporarily slide the bolt through the transducer assembly but don't tighten the nut at this time. Hold the assembled transducer and bracket against the transom. Looking at the transducer from the side, check to see if it will adjust so that its face is parallel to the ground. If it does, then the "A" positions are correct for your hull.

If the transducer's face isn't parallel with the ground, remove and disassemble the transducer and ratchets. Place the ratchets into the bracket holes with the letter "B" aligned with the bracket alignment mark. Place them on the transducer aligned with the 12 o'clock position on the transducer stem.

Reassemble the transducer and bracket and place them against the transom. Again, check to see if you can move the transducer so it's parallel with the ground. If you can, then go to step 3B. If it doesn't, repeat step 2B, but use a different alignment letter until you can place the transducer on the transom correctly.

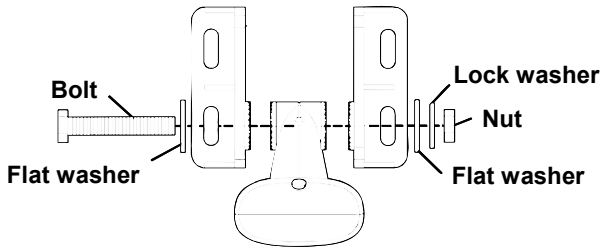

Assemble transducer and bracket.

3. Assembling the transducer.

A. One-piece bracket: Once you determine the correct position for the ratchets, assemble the transducer as shown in the following figure. Don't tighten the lock nut at this time.

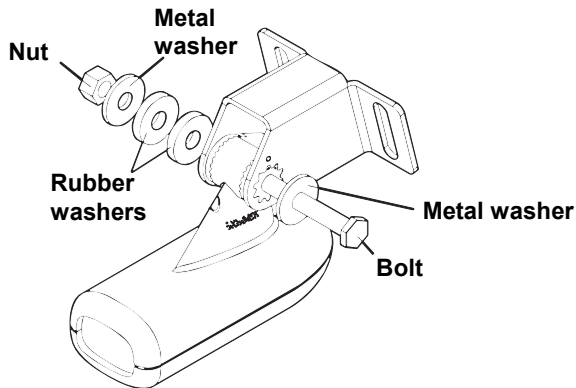

Assemble transducer and bracket.

B. Two-piece bracket: Once you determine the correct position for the ratchets, assemble the transducer as shown in the figure in step 2B. Don't tighten the lock nut at this time.

4. Drilling mounting holes.

Hold the transducer and bracket assembly against the transom. The transducer should be roughly parallel to the ground. The transducer's centerline should be in line with the bottom of the hull. Don't let the bracket extend below the hull!

Mark the center of each slot for the mounting screw pilot holes. You will drill one hole in the center of each slot.

Drill the holes. For the one-piece bracket, use the #29 bit (for the #10 screws). For the two-piece bracket, use the #20 bit (for the #12 screws).

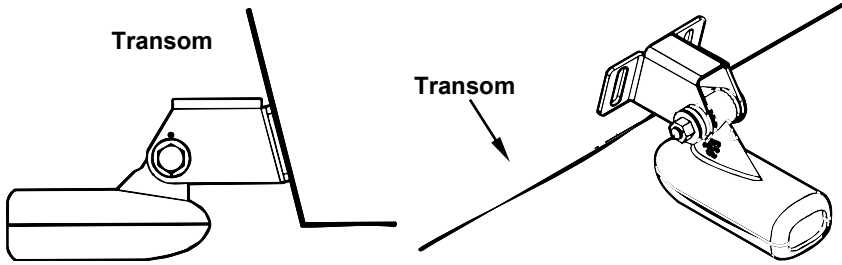

Position transducer mount on transom and mark mounting holes.
Side view shown, left, and seen from above at right.

5. Attaching transducer to transom.

A. One-piece bracket: Remove the transducer from the bracket and re-assemble it with the cable passing through the bracket over the bolt as shown in the following figures.

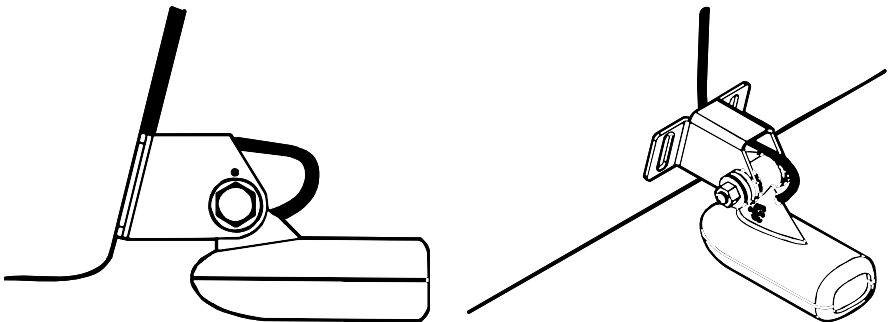

For single-frequency Skimmer, route cable over bolt and through bracket. Side view shown, left, and seen from above at right.

Both bracket types: Attach the transducer to the transom. Slide the transducer up or down until it's aligned properly with the bottom of the hull as shown in the preceding and following figures. Tighten the bracket's mounting screws, sealing them with the sealant.

Adjust the transducer so that it's parallel to the ground and tighten the nut until it touches the outer washer, then add 1/4 turn. *Don't over tighten the lock nut!* If you do, the transducer won't "kick-up" if it strikes an object in the water.

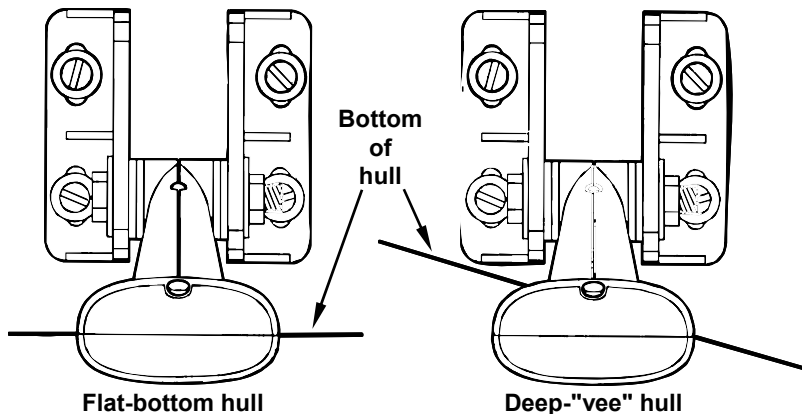

Align transducer centerline with hull bottom and attach transducer to transom. Rear view of dual-frequency Skimmer shown.

6. Route the transducer cable through or over the transom to the sonar unit. Make sure to leave some slack in the cable at the transducer. If possible, route the transducer cable away from other wiring on the boat. Electrical noise from the engine's wiring, bilge pumps, VHF radio wires and cables, and aerators can be picked up by the sonar. Use caution when routing the transducer cable around these wires.

WARNING:

Clamp the transducer cable to the transom close to the transducer. This can prevent the transducer from entering the boat if it is knocked off at high speed.

If you need to drill a hole in the transom to pass the connector through, the required hole size be 1".

Caution:

If you drill a hole in the transom for the cable, make sure it is located above the waterline. After installation, be sure to seal the hole with the same marine grade above- or below-waterline sealant used for the mounting screws.

7. **Make a test run to determine the results.** If the bottom is lost at high speed, or if noise appears on the display, try sliding the transducer bracket down. This puts the transducer deeper into the water, hopefully below the turbulence causing the noise. Don't allow the transducer bracket to go below the bottom of the hull!

Trolling Motor Bracket Installation (single-frequency only)

1. Attach the optional TMB-S bracket to the transducer as shown in the following figure, using the hardware supplied with the transducer. (Note: The internal tooth washer is supplied with the TMB-S.)

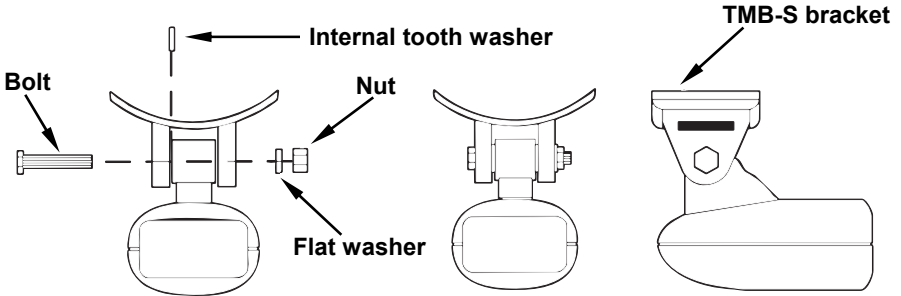

Attach motor mounting bracket to transducer.

2. Slide the adjustable strap supplied with the TMB-S through the slot in the transducer bracket and wrap it around the trolling motor. Position the transducer to aim straight down when the motor is in the water. Tighten the strap securely.
3. Route the transducer cable alongside the trolling motor shaft. Use plastic ties (not included) to attach the transducer cable to the trolling motor shaft. Make sure there is enough slack in the cable for the motor to turn freely. Route the cable to the sonar unit and the transducer is ready for use.

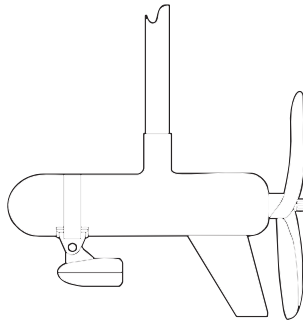

Transducer mounted on trolling motor, side view.

Transducer Orientation and Fish Arches

If you do not get good fish arches on your display, it could be because the transducer is not parallel with the ground when the boat is at rest in the water or at slow trolling speeds.

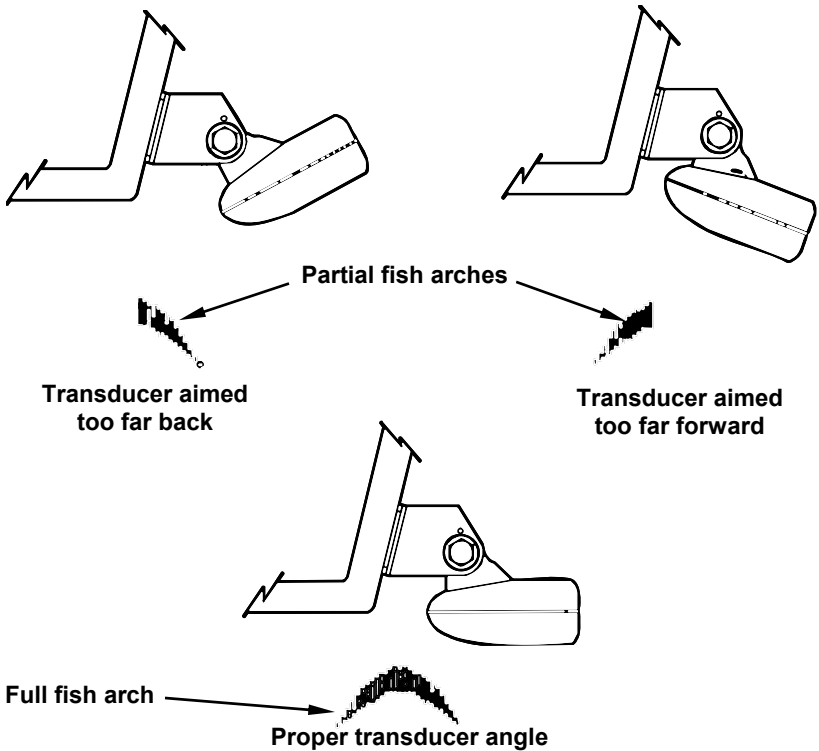

Transducer angles and their effects on fish arches.

If the arch slopes up – but not back down – then the front of the transducer is too high and needs to be lowered. If only the back half of the arch is printed, then the nose of the transducer is angled too far down and needs to be raised.

NOTE:

Periodically wash the transducer's face with soap and water to remove any oil film. Oil and dirt on the face will reduce the sensitivity or may even prevent operation.

Shoot-Thru-Hull Preparation

Hulls With Floatation Materials

The transducer installation inside a fiberglass hull must be in an area that does not have air bubbles in the resin or separated fiberglass layers. The sonar signal must pass through solid fiberglass. A successful transducer installation can be made on hulls with flotation materials (such as plywood, balsa wood or foam) between layers of fiberglass if the material is removed from the chosen area. See the following figure.

WARNING:

Do not remove any material from your inner hull unless you know the hull's composition. Careless grinding or cutting on your hull can result in damage that could sink your boat. Contact your boat dealer or manufacturer to confirm your hull specifications.

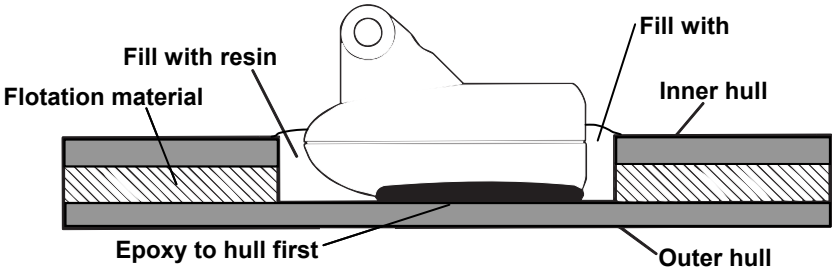

Epoxy the transducer to a solid portion of the hull.

For example, some (but not all) manufacturers use a layer of fiberglass, then a core of balsa wood, finishing with an outer layer of fiberglass. Removing the inner layer of fiberglass and the balsa wood core exposes the outer layer of fiberglass. The transducer can then be epoxied directly to the outer layer of fiberglass. After the epoxy cures for 24 hours, fill the remaining space with polyester resin. When the job is finished, the hull is watertight and structurally sound. Remember, the sonar signal must pass through *solid* fiberglass. Any air bubbles in the fiberglass or the epoxy will reduce or eliminate the sonar signals.

Testing Determines Best Location

Ideally, the shoot-thru transducer should be installed as close to the transom as possible, close to the centerline. This will give you the best performance during high speed maneuvers.

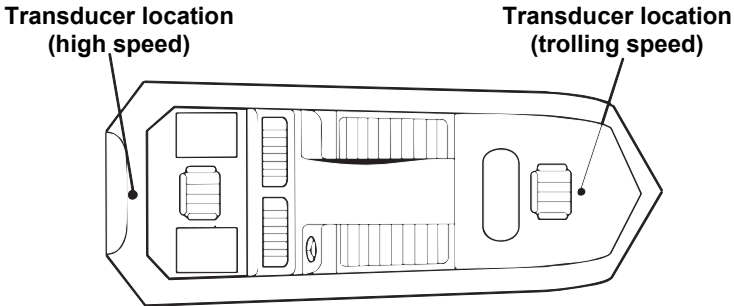

Shoot-thru-hull transducer locations for high speed or trolling speed operation.

To choose the proper location for shoot-thru-hull mounting, follow these testing procedures: (You may need a helper to complete these steps.)

1. Anchor the boat in about 30 feet of water. Add a little water to the sump of the boat. Plug the transducer into the sonar unit, turn it on, then hold the transducer over the side of the boat in the water. Adjust the sensitivity and range controls until a second bottom echo is seen on the display. (You'll need to turn off Auto Sensitivity, Auto Depth Range and ASP™. Try a range setting that is two to three times the water depth. The harder (more rocky) the bottom, the easier it will be to get a second bottom signal.) Don't touch the controls once they've been set.

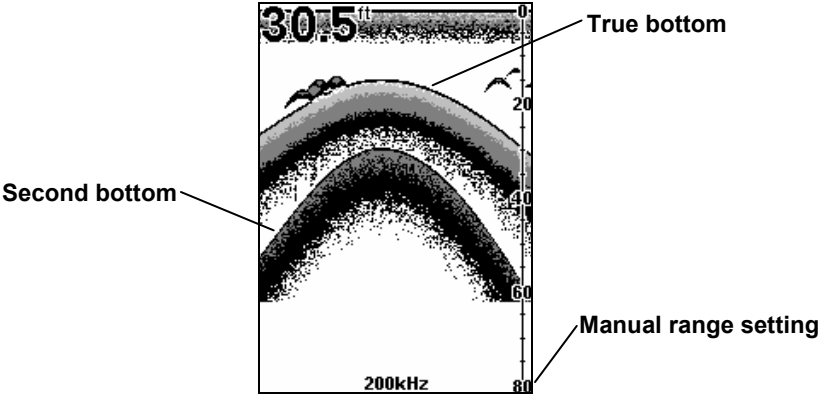

Example of a second bottom signal. Unit is in 30 feet of water, with range set at 80 feet and sensitivity set at 87 percent.

2. Next, take the transducer out of the water and place it in the water in the sump of the boat, face down. (The transducer face is shown in the figure on the following page.) Notice how the signal strength decreases. The second bottom signal will probably disappear and the bottom signal intensity will likely decrease.
3. Now move the transducer around to find the best location with the strongest possible bottom signal. If you find a spot with an acceptable bottom signal, mark the location and move on to step 4.
If you can't get an acceptable bottom signal, try turning up the sensitivity by three or five keystrokes and then move the transducer around once more. If you find a spot that works, mark it and move on to step 4.
If you have to turn up sensitivity by more than five keystrokes to get a good signal, the transducer should be mounted on the outside of the hull. This is especially true if you have to turn sensitivity all the way up to get a decent bottom signal.
4. Most people can get good results by following steps 1 through 3, so this step is *optional*. If you want to make an extra effort to be absolutely

sure that your selected location will work under all conditions, make a test run with the boat on plane and observe the bottom signal. You'll need to figure some way to prop the transducer into position while you make your test run. (A brick or two might be sufficient to hold it in place.)

5. When you're satisfied with a location, mark it and proceed with the installation.

Shoot-thru-hull Installation

If you are installing the transducer on a hull with floatation material sandwiched within the hull, refer to the text "Hulls With Flotation Materials" beginning on page 18.

1. Make sure the area is clean, dry and free of oil or grease, then sand both the inside surface of the hull and the face of the transducer with 100 grit sandpaper. The sanded hull area should be about 1-1/2 times the diameter of the transducer. The surface of the hull must be flat so the entire transducer face is in contact with the hull prior to bonding. After sanding, clean the hull and transducer with rubbing alcohol to remove any sanding debris.

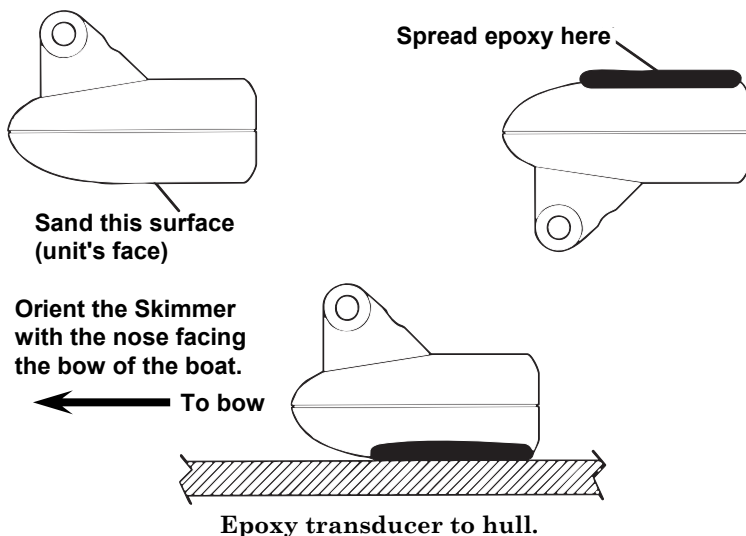

WARNING:

Use *only* the epoxy available from LEI. It has been formulated to work with these installation procedures. Other epoxy types may be too thin or may not cure to the right consistency for optimum transducer performance.

2. The epoxy consists of the epoxy itself and a hardener. Remove the two compounds from the package and place them on the paper plate. Thoroughly stir the two compounds together until the mixture has a uniform color and consistency. Do not mix too fast or bubbles will form in the epoxy. After mixing, you have 20 minutes to complete the installation before the epoxy becomes unworkable.
Spread a thin layer of epoxy (about 1/16" or 1.5 mm thick) on the face of the transducer as shown in the previous figure. *Make sure there are no air pockets in the epoxy layer!* Then, apply the remaining epoxy to the sanded area on the hull.
3. Press the transducer into the epoxy, twisting and turning it to force any air bubbles out from under the transducer face. Stop pressing when you bottom out on the hull. When you're finished, the face of the transducer should be parallel with the hull, with a minimum amount of epoxy between the hull and transducer.
4. Apply a weight, such as a brick, to hold the transducer in place while the epoxy cures. Be careful not to bump the transducer while the epoxy is wet. Leave the weight in place for a minimum of three hours. Allow the epoxy to cure for 24 hours before moving the boat.
5. After the epoxy has cured, route the cable to the sonar unit and it's ready to use.

Speed/Temperature Sensors

Optional Speed Sensor Installation

All the units in this series can display speed and distance traveled, but only the X-515cDF comes packed with a speed sensor. If you wish to purchase an optional additional sensor for your unit, refer to the accessory ordering information inside the back cover of this manual. The following instructions describe how to install the speed sensor.

Recommended tools for this job include: drill, 7/8" drill bit, 1/8" drill bit for pilot holes, screwdriver. Required supplies for this job include: four #8 stainless steel wood screws (3/4" long), *high quality, marine grade* above- or below-waterline sealant.

First find a location on the boat's transom where the water flow is smoothest. Don't mount the sensor behind strakes or ribs. These will disturb the water flow to the speed sensor. Make sure the sensor will remain in the water when the boat is on plane. Also make sure the location doesn't interfere with the boat's trailer. Typically, the sensor is mounted about one foot to the side of the transom's centerline. Once you've determined the proper location for the unit, place the sensor on

the transom. The bottom of the bracket should be flush with the hull's bottom. Using the sensor as a template, mark the hull for the screws' pilot holes. Drill four 1/8" holes, one in each end of the slots.

Mount the sensor to the hull using #8 stainless steel wood screws (not included). Use a *high quality, marine grade* above- or below-waterline sealant to seal the screws. Make sure the sensor is flush with the bottom of the hull and tighten the screws.

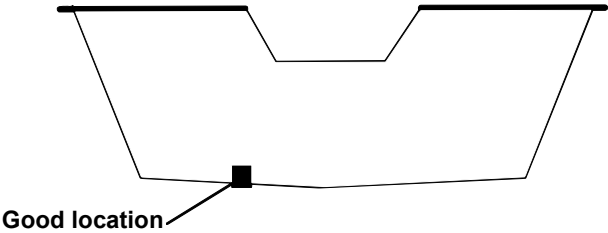

Stern view showing good location for mounting sensor on transom.

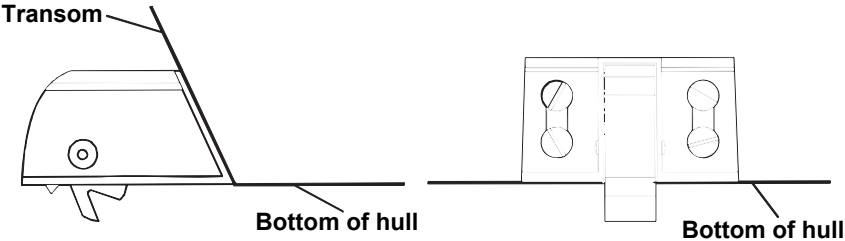

**Speed sensor mounting configuration:
side view (left) and rear view (right.)**

If the base of the transom has a radius, fill the gap between the transom and the sensor with the sealant. This will help ensure a smooth water flow.

Route the sensor's cable through or over the transom to the sonar unit. If you need to drill a hole in the transom to pass the connector through, the required hole size is 7/8".

CAUTION:

If you drill a hole in the transom for the cable, make sure it is located above the waterline. After installation, be sure to seal the hole with the same marine grade above- or below-waterline sealant used for the screws.

The sensor is now ready for use. Connect the sensor to the sonar socket on the back of your unit and connect the transducer to the speed sensor's socket. If you have any questions concerning the installation of the sensor, please contact your local boat dealer.

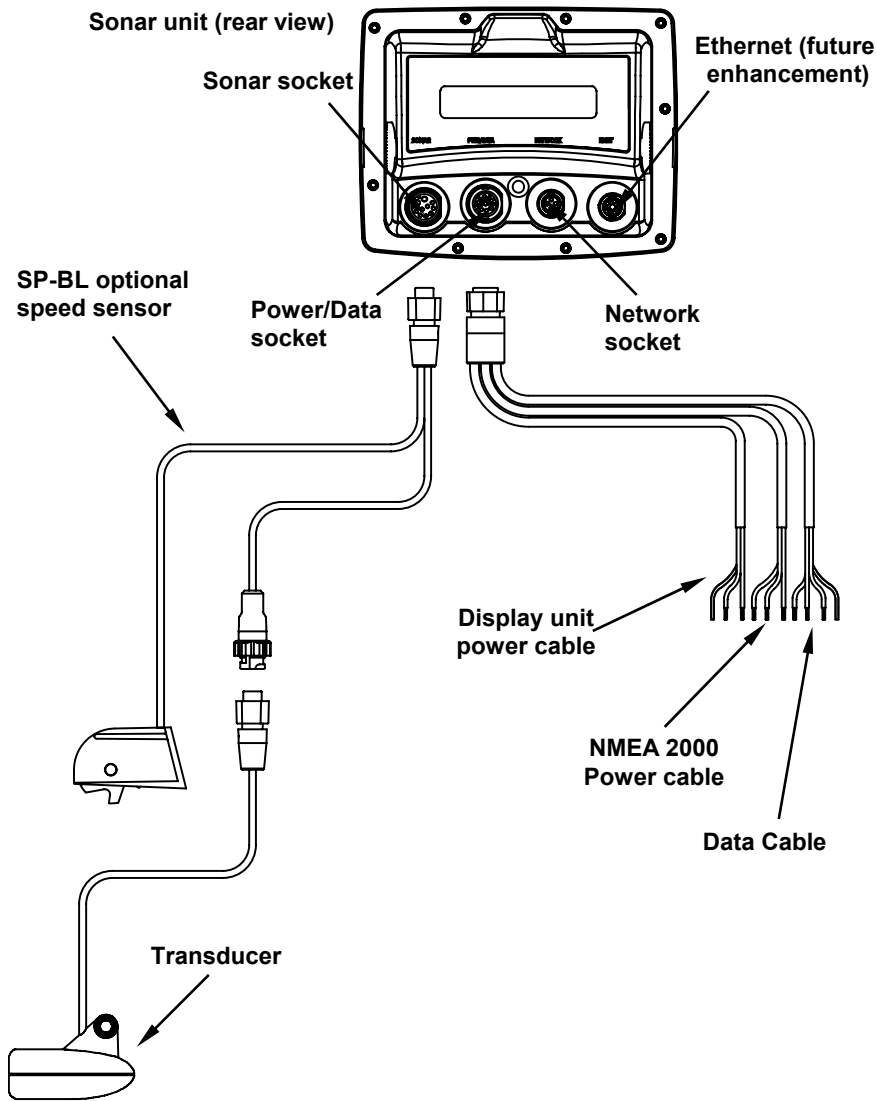

Sonar unit cable connections.

Power Connections

Your unit comes with a power/data cable that splits into three branches, each with several exposed wires.

The thicker three-wire cable (white, red and black) is the power supply for your display unit. This cable has no label.

The thinner branch with three wires (red, black and shield) is the power cable for a NMEA 2000 network. It is labeled "NMEA 2000 POWER."

The branch with four wires (blue, yellow, orange, and shield) is a data cable, labeled "RS-232 COMM." It supports a serial communication port. This allows your unit to exchange NMEA 0183 data with another device, such as an autopilot, DSC marine radio or computer.

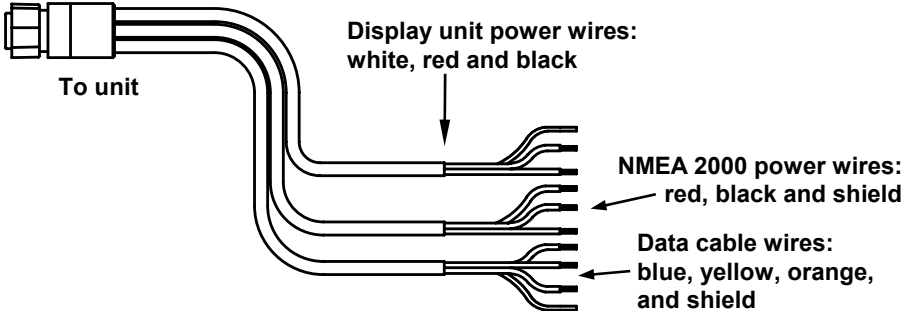

The Power/Data cable for this unit.

NOTE:

There are two basic power connection options, which are shown in the following two diagrams. *Read the following instructions carefully to determine which power connection applies to your unit.* Depending on your configuration, you may not use all of these wires.

Caution:

All of the wires in the power/data cable have bare ends for easier installation. The bare ends on any unused wires could cause an electrical short if left exposed. To prevent this, you should cover the individual wire ends – either by capping them with wire nuts, wrapping them with electrical tape or both. (You should cut off the bare wire before taping off the ends.)

Powering Your Display Unit

The display unit works from a 12-volt DC battery system. Attach the display power cable (with provided 3-amp fuse) to an accessory switch or power bus. If this results in electrical interference, connect direct to a battery but install an in-line switch on the cable.

Caution:

We strongly recommend that you shut off the power supply to the power cable when the unit is not in use, especially in saltwater en-

vironments. When the unit is turned off but still connected to a power supply, electrolysis can occur in the power cable plug. This may result in corrosion of the plug body along with the electrical contacts in the cable and the unit's power socket. Risk of electrolysis corrosion is even greater when the cable is unplugged from the unit, but still connected to a power source.

We recommend you connect the power cable to the auxiliary power switch included in most boat designs. If that results in electrical interference, or if such a switch is not available, we recommend connecting direct to the battery and installing an in-line switch. This will let you shut off power to the power cable when the unit is not in use. When you are not using the unit, you should always shut off power to the power cable, especially when the power cable is disconnected from the unit.

WARNING:

This product *must* be independently fused with the enclosed 3-amp fuse (or equivalent), even if you connect to a fused accessory or power bus.

If a malfunction happens inside the unit, extensive damage can occur if the enclosed fuse is not used. As with all electrical devices, this unit could be damaged to a point that it is unrepairable and could even cause harm to the user when not properly fused.

Failure to use a 3-amp fuse will void your warranty.

If possible, keep the power cable away from other boat wiring, especially the engine's wires. This will provide the best isolation from electrical noise. If the cable is not long enough, splice #18 gauge wire onto it.

The display power cable has three wires, white, red and black. Red is the positive (+) lead, black is negative (-) or ground. The white wire is unused by your unit and should be capped. Make sure to attach the in-line fuse holder to the red lead *as close to the power source as possible*.

For example, if you have to extend the power cable to the power bus or battery, attach one end of the fuse holder directly to the power bus or battery. This will protect both the unit and the power cable in the event of a short.

This unit has reverse polarity protection. No damage will occur if the power wires are reversed. However, the unit will not work until the wires are attached correctly.

Power Diagram A

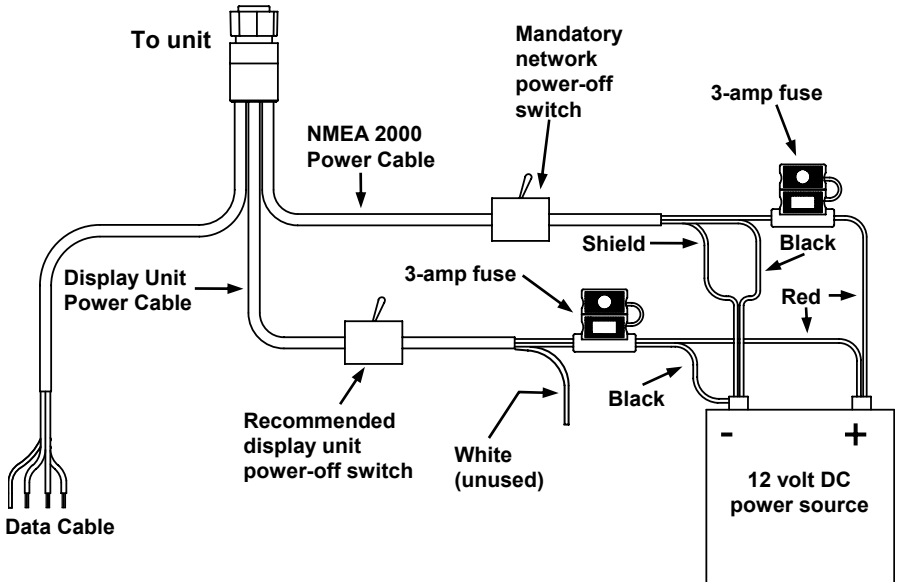

Use this method if you are powering the display unit and or the display unit and a NMEA 2000 network. (Fuses may be different from those shown.).

The network and any NMEA 2000 devices will not operate unless the NMEA 2000 Power Cable is connected to power. (However, never connect multiple power sources to a NMEA 2000 network. If you have a network that is already powered, see diagram B on page 28.)

The method in diagram B is also used when your display unit is connected to a NMEA 2000 network *that is already connected to power.* (Never connect multiple power sources to a NMEA 2000 network.)

Power Diagram B

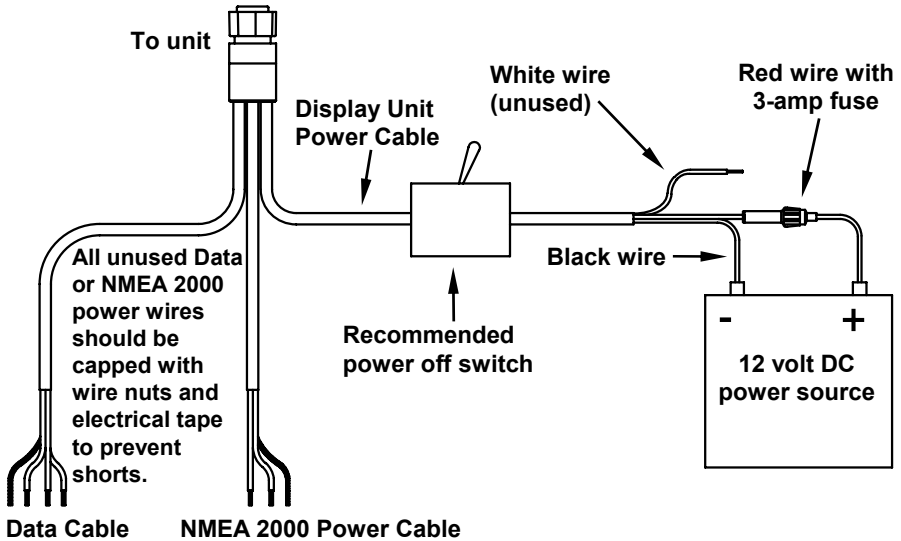

Use this method if you are *only* powering your display unit and are not powering a NMEA 2000 network or any NMEA 2000 accessory device. (Fuse may be different from that shown.)

Powering a NMEA 2000 Network Bus

A NMEA 2000 bus must be connected to a power source to operate. NMEA 2000 devices draw their power from the network bus.

If you have a pre-existing NMEA 2000 network installation, it may already be connected to another power source. If you are not sure about a network's power status, consult the boat manufacturer or dealer. *If* your NMEA 2000 bus is already powered, you can ignore the NMEA 2000 Power cable and use the method shown in Power Diagram B above. ***Never attach two power sources to a single NMEA 2000 bus.***

If you do need to power your NMEA 2000 bus, attach the NMEA 2000 Power cable to an accessory switch as indicated in power diagram A on page 27. The NMEA 2000 Power cable's red wire should be attached (with provided 3-amp fuse) to the positive (+) terminal. The NMEA 2000 Power cable's black and shield wires should both be attached to the negative (-) terminal.

WARNING:

The NMEA 2000 network bus is always on and constantly drawing power. You must connect NMEA power to a switched power source so you can turn off the network

when not in use. Failure to connect to and use a power switch will drain your boat battery, which could stop your boat's operation.

Connecting to a NMEA 2000 Network

Your unit can be connected to a NMEA 2000 bus, receiving sensor information from units and devices attached to the network. Contact LEI Extras (look inside back cover for accessory ordering information) for NMEA 2000 accessories.

NMEA 0183 Cable Connections

NMEA is a standard communications format for marine electronic equipment, mainly navigation equipment. Your sonar unit cannot currently communicate with the NMEA 0183 format, so the Data cable wires will not be used.

Mounting the Unit: Bracket, In-Dash or Portable

You can install the sonar unit on the top of a dash with the supplied gimbal bracket. It can also be installed in the dash or mounted on a portable power supply. If you use the supplied bracket, you may be interested in the optional R-A-M[®] bracket mounting system. This converts the unit's gimbal bracket to a swivel mount, which can be used on the dash or overhead mounting positions. Installation instructions are supplied with the R-A-M mounting kits.



Optional R-A-M mounting system.

Bracket Installation

Mount the unit in any convenient location, provided there is clearance behind the unit when it's tilted for the best viewing angle. You should also make sure there is enough room behind the unit to attach the

power and transducer cables. (A drawing on the next page shows the dimensions of a gimbal-mounted sonar unit.)

Holes in the bracket's base allow wood screw or through-bolt mounting. You may need to place a piece of plywood on the back side of thin fiberglass panels to reinforce the panel and secure the mounting hardware.

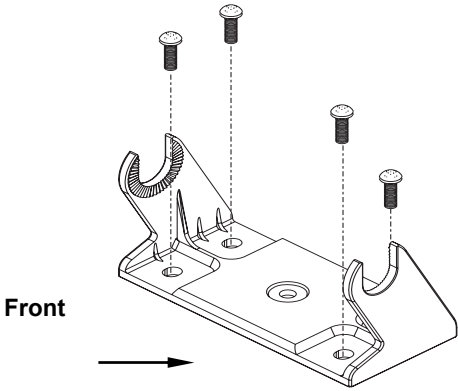

Install the gimbal bracket. Orient the bracket so the arms slope toward the front of your unit.

Drill a 1-inch (25.4 mm) hole in the dash for the power and transducer cables. The best location for this hole is immediately under the gimbal bracket location. This way, the bracket can be installed so that it covers the hole, holds the cables in position and results in a neat installation. Some customers, however, prefer to mount the bracket to the side of the cable hole — it's a matter of personal preference.

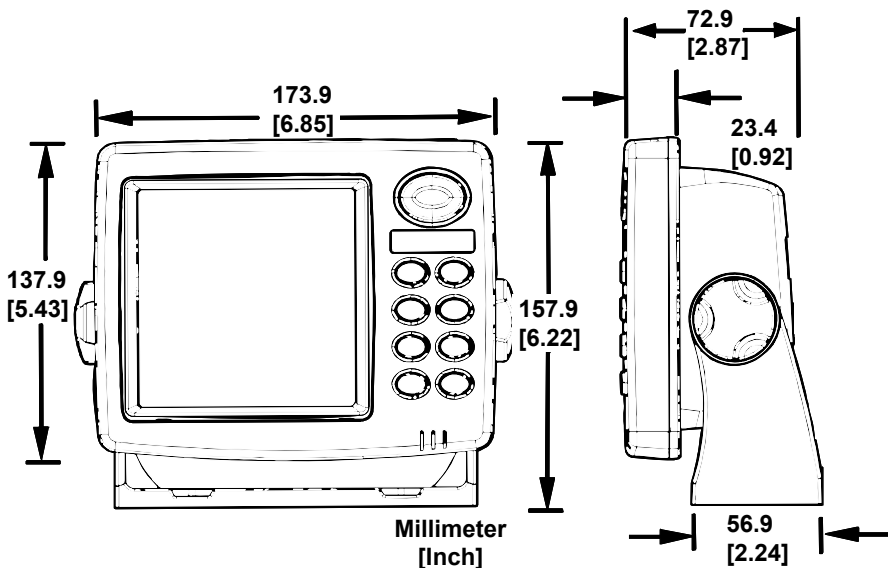

Front view (left) and side view (right) showing dimensions of the sonar unit when mounted on gimbal bracket.

After drilling the hole, pass the transducer connector *up* through the hole from under the dash. Pass the power cable's bare-wire end *down* through the hole from the top.

If you wish, you can fill in the hole around the cables with a good marine caulking compound. (Some marine dealers stock cable hole covers to conceal the opening.) No matter what type of installation you prefer, be sure to leave enough slack in the cables to allow tilting or swiveling the unit. If you choose to fill in the hole, be sure to position the cables against the rear edge of the hole as you apply the fill material.

Before positioning the bracket, be sure to hold the cables against the rear edge of the hole. Then, slide the bracket over the hole and butt the rear of the bracket base firmly against the cables, thus pinning them in place against the side of the hole. Finally, fasten the bracket to the dash. Attach the unit to the gimbal bracket using the supplied gimbal knobs and washers.

In-Dash Installation

You can mount the unit in the dash with an optional FM-5 In-Dash Adapter Kit. The kit includes mounting hardware, a template for cutting the hole and an instruction sheet, part 988-0147-43.

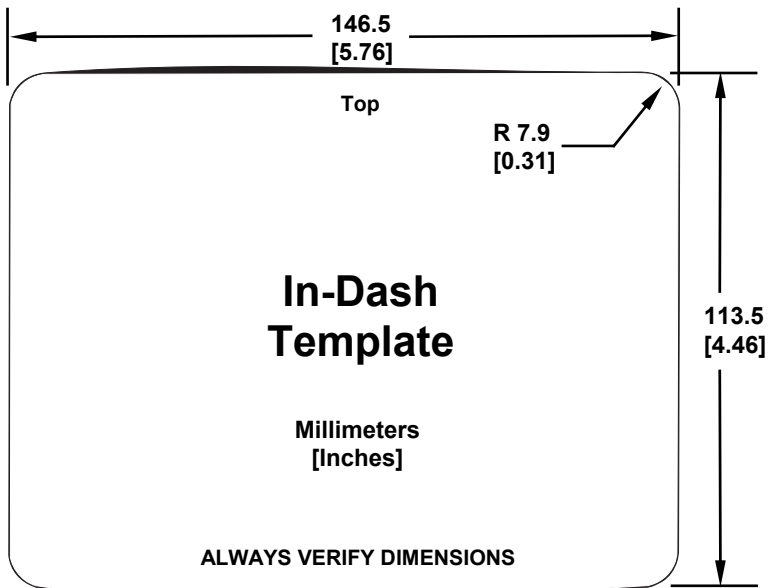

In-dash mounting template for the sonar unit, showing dimensions. NOTE: The figure above is *not* printed to scale. A scaled template (FM-5 In-Dash Adapter Kit instructions) is available for free download from our web site, www.lowrance.com.

Portable Installation

Like many Lowrance products, the unit is capable of portable operation by using an optional portable power pack. The power pack, a magnet-equipped antenna module and an optional portable transducer, expands the uses for your sonar unit. It makes it easy to transfer your unit from a boat to a car, recreational vehicle, airplane or other vehicle without mounting a second bracket. You can use it in your own car or boat, then take it along when riding in a friend's vehicle.

The power pack can be used with eight "D" cell alkaline batteries or an optional sealed, rechargeable battery. Visit our web site for a complete listing of all the available portable power packs.



PPP-15 Portable Power Pack with transducer installed. Shown with the X67C IceMachine™ .

Other Accessories

Cleaning Towel

A lint-free microfiber towel is included for cleaning the unit's screen. The towel is highly effective in clearing away water spots, smudges and finger prints. Just wipe the screen with the dry towel — it's not necessary to moisten the towel with water. If the screen is badly soiled, you may use water or common window or lens cleaners. However, **DO NOT** use polishing compounds or any other abrasive product.

If you lose the towel or wear it out, you can replace it with a similar microfiber cloth. These are often available where shop towels or automobile cleaning towels are sold.

Caution:

Cleaning fabrics other than the microfiber towel type may scratch the screen. Polishing compounds or other abrasive cleaners will scratch the screen. Damage caused by incorrect cleaning is not covered by the warranty. You may wash the towel if it becomes soiled or loses its effectiveness, but do not use fabric softener. Fabric softener will ruin the towel's cleaning capability.

Face Cover

Your unit comes with a white protective cover that snaps on and off the front of the unit. This cover is intended for use when your unit and the vehicle it's mounted in are idle.

WARNING:

When the unit is mounted in an unprotected area, such as an open boat cockpit, the protective face cover must be removed when the vehicle is moving at high speed. This includes towing a boat on a trailer at highway speeds. Otherwise, wind blast can pop off the cover.

Section 3: Basic Sonar Operation

This section addresses the unit's *most basic* sonar operations. The instructions presented here in Sec. 3 follow a chronological order. Sec. 4, *Sonar Options & Other Features*, will discuss options and other more advanced functions and utilities. The material in Sec. 4 is arranged in alphabetical order.

Before you turn on the unit, it's a good idea to learn about the different keys, the Main Menu, the Sonar Menu, the five Page options and how they all work together. BUT, if you just can't wait to get on the water, turn to the one-page **Quick Reference** on page 43.

Keyboard



Sonar unit, front view, with keyboard. X-515cDF shown.

1. **PWR/LIGHT** (Power & Light) – The PWR key turns the unit on and off and activates the backlight.
2. **PAGES** – Pressing this and the $\uparrow \downarrow$ arrow keys switches the unit between the five different page options. (Full Sonar Chart, Split Zoom Sonar Chart, Split Frequency Sonar Chart, Digital Data and FlashGraf™.)
3. **MENU** – Press this key to show the menus and submenus, which allow you to select a command or adjust a feature.

4. **ARROW KEYS** – These keys are used to navigate through the menus, make menu selections, move the sonar chart cursor and enter data.
5. **ENT (Enter)** – This key allows you to accept values or execute menu commands.
6. **EXIT** – The Exit key lets you return to the previous screen, clear data or erase a menu.
7. **ALARM** – The Alarm key is a quick shortcut to the sonar alarms menu. It allows you to choose which alarms to use and when.
8. **ZOUT** – (Zoom Out) – This key lets you zoom the screen out. This key returns you to a full sonar chart display, showing the entire water column from surface to bottom.
9. **ZIN** – (Zoom In) – This key lets you zoom the screen in. It enlarges fish signals, bottom detail and other sonar returns.

Power/lights on and off

To turn on the unit, press **PWR**.

To change the backlight, press **PWR** again. The X-510c and X-515cDF have three backlight levels. Repeatedly pressing **PWR** will cycle through the backlight settings, turn off the backlight, then turn it back on again.

Turn off the unit by pressing and holding the **PWR** key for about 3 seconds.

Menus

Your sonar unit will work fine right out of the box with the factory default settings. You only need to learn a few basic functions to enhance your viewing. We'll discuss them briefly here, then talk about them and all the other commands in more detail in the next section, which begins on page 49.

Your unit has three primary menus that control its operation. They are the Main Menu, the Sonar Menu and the Pages Menu.

Main Menu

The Main Menu contains some basic function commands and some setup option commands. You access the Main Menu by pressing **MENU | MENU**. You run a command by using the **↑** or **↓** to highlight the command and then pressing **ENT**. To clear the Main Menu screen and return to the Page display, press **EXIT**. (Remember, our text style for "**MENU | MENU**" means "press the Menu key twice." See a full explanation of our instruction text formatting on page 4, *Instructions = Menu Sequences*.)

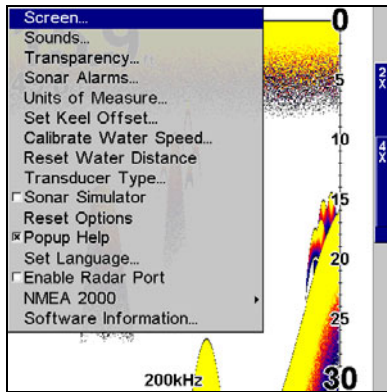

Main Menu.

Main Menu Commands

There are four "basic" Main Menu commands that you'll really want to read more about. They are:

- **Screen:** changes the contrast or brightness of the display screen. Use this command to adjust how the screen looks under various lighting conditions.
- **Sounds:** enables or disables the sounds for key strokes and alarms, controls the volume and sets the alarm style. If you don't like to hear a beep each time you press a key, you can turn this off, or select tunes or sound effects instead. The sounds are especially useful when used with the Fish I.D.[™] fish symbol feature and fish alarm feature.
- **Sonar Alarms:** turns alarms on or off and changes alarm thresholds. The fish alarm, used with Fish I.D., is the most popular use. It tells you when the sonar sees a fish. You can also set deep or shallow depth alarms and zone alarms.
- **Popup Help:** turns the pop-up help boxes on or off. When you select a menu command, these information boxes appear to tell you what the command does or how to use the command. The default setting is on, which is really handy while you're learning.

The remaining Main Menu commands are for more advanced functions, mostly setting various sonar options. (They're all detailed in Sec. 4.)

- **Transparency:** adjust the level of transparency for menus.

Units of Measure: selects the units of measure used for showing speed/distance, depth and temperature.

- **Set Keel Offset:** calibrates the unit to show depth under the keel or actual depth from the surface.

- **Calibrate Water Speed:** adjusts how a speed sensor measures water speed.
- **Reset Water Distance:** resets water distance log to zero.
- **Sonar Simulator:** turns the simulator feature on and off.
- **Transducer Type** (dual-frequency units only): sets the type of transducer plugged into the unit.
- **Reset Options:** returns all options and auto functions to their original factory settings. It's a great safety net while you're learning and experimenting with various settings.
- **Set Language:** your unit has menus in 10 different languages. This command switches from one language to another.
- **Enable Radar Port:** allows you to turn the radar port on and off.
- **NMEA 2000:** gives you access to all NMEA 2000 network setup options, including the configuration of devices on the network.
- **Software Information:** tells you which version of the operating software is loaded in your unit.

Sonar Menu

The Sonar Menu contains commands for the major sonar features and options. You access the Sonar Menu by pressing the **MENU** key one time. You run a command by using the **↑** or **↓** to highlight the command and then pressing **ENT**. To clear the menu screen and return to the Page display, press **EXIT**.

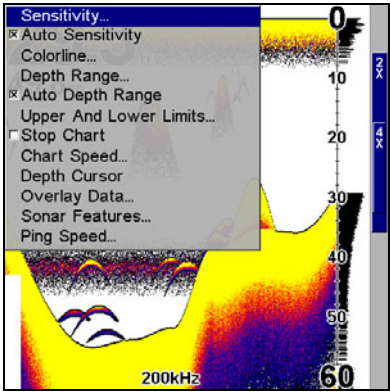

Sonar Page Menu.

Sonar Menu Commands

The Sonar Menu contains commands for the major sonar features and options. Most of them are only described in detail in Sec. 4, but Sensitivity and Auto Sensitivity are important basic functions that are discussed both here and in Sec. 4. The other Sonar Menu commands include:

- **Colorline** command: separates fish and structure near the bottom from the actual bottom, and defines bottom composition and hardness.
- **Depth Range** command: manually sets the depth range shown on the sonar chart.
- **Auto Depth Range** command: automatically sets the depth range shown on the sonar chart to always keep the bottom in view.
- **Upper and Lower Limits** command: sets the upper and lower depth limits of the sonar chart. Lets you zoom in on a specific portion of the water column.
- **Stop Chart** command: stops the sonar chart from scrolling. Used when you want to "freeze" the image for closer study.
- **Chart Speed** command: sets the scrolling speed of the sonar chart.
- **Depth Cursor** command: displays a cursor line on the sonar chart which allows you to accurately measure the depth of a sonar target.
- **Overlay Data** command: chooses what types of information (such as water temperature) to show overlaid on the sonar chart screen.
- **Sonar Features** command: launches the Sonar Features menu which controls many functions and options, including frequency selection, screen color mode, auto depth and sensitivity, surface clarity, noise rejection, Fish I.D.[™] symbols, the zoom bar and zone bar.
- **Ping Speed** command: sets the rate at which sonar pings are made.

Pages

The Pages Menu has two tabs, one for sonar, the other for radar. The Sonar tab has six major display options: Full Sonar Chart, Split Zoom Sonar Chart, Split Frequency Sonar Chart (X-515cdf only), Digital Data, Flasher and Sonar with Custom Gauges. Select the Radar tab to display the radar page.

You can access the Pages Menu by pressing the **PAGES** key. You select a display option by using \uparrow or \downarrow to highlight the option and then pressing **ENT**. (You can clear the Pages Menu by pressing **EXIT**.)

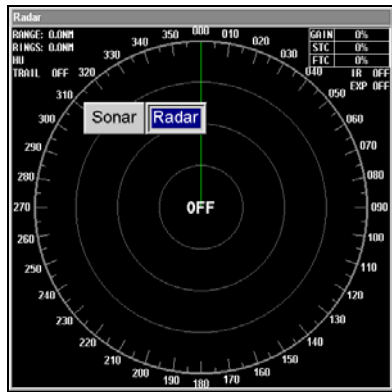
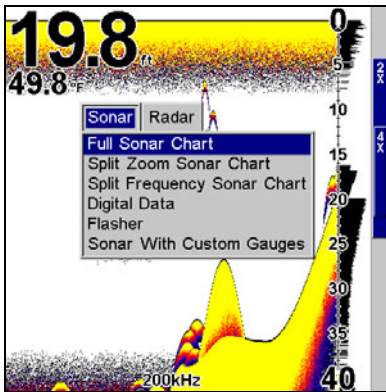

Sonar Page Display options (left). Radar Page (right). Remember: the Split Frequency Sonar Chart will not be listed on the X-510c menu since it does not have a dual frequency transducer.

The Full Sonar Chart is the main display option. This is a "cross-section" view of the water column beneath the boat. The chart moves across the screen, displaying sonar signal echoes that represent fish, structure and the bottom.

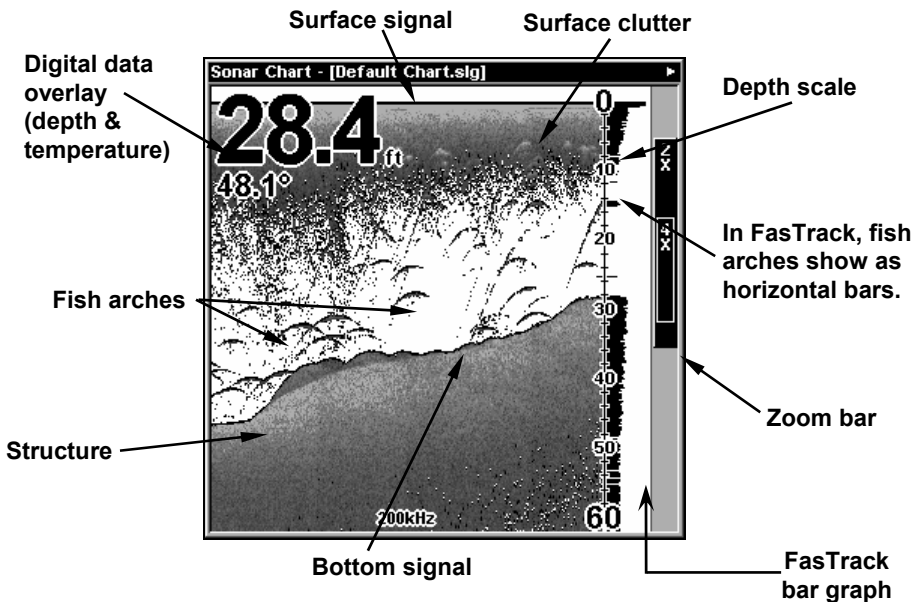

Sonar Page, showing full sonar chart mode.

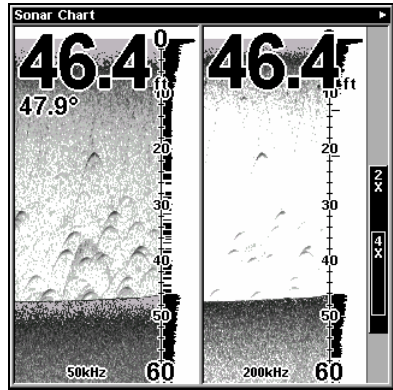
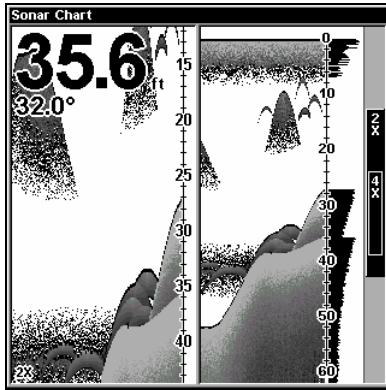

Split zoom page (left) with split frequency page (X-515 only) (right).

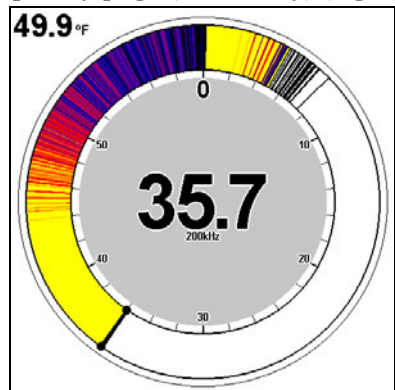
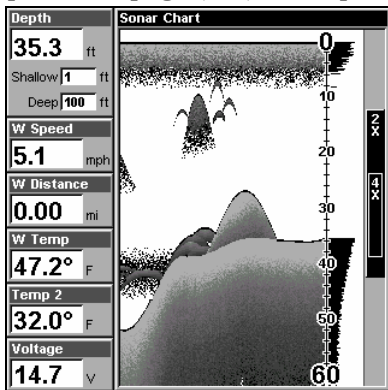

Digital Data page display (left) with the Flasher page (right).

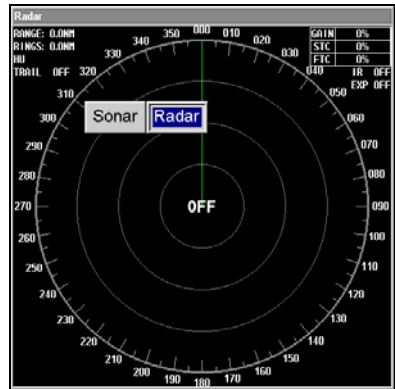
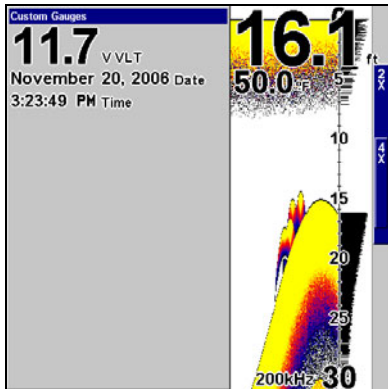

Sonar with Custom Gauge page (left). Radar page display (right).

You can customize how the Sonar Page pictures and other data are displayed in many ways. We'll discuss all of those features and options in

Section 4, but to show you how easy the sonar unit is to operate, the following page contains a simplified, 10-step quick reference that will cover most fish finding situations. The quick reference describes how your unit will operate with all the sonar features in their automatic modes, which are set at the factory.

Basic Sonar Quick Reference

1. Depress the **PWR** key to turn on the unit.
2. Head for your fishing grounds. Your unit automatically displays digital depth and surface water temperature in the corner of the screen.

The auto settings will track the bottom, displaying it in the lower portion of the screen. The full sonar chart will scroll from right to left, showing you what's under the boat as you cruise across the water.

3. As you're watching the sonar returns, you can change the display by:

Zoom in to enlarge the chart for more detail: press **ZIN**.

Zoom out to return to full chart mode: press **ZOUT**.

4. If necessary, adjust sensitivity to improve chart readability. Press **MENU|ENT** and the Sensitivity Menu will appear on the left of your screen. Use **↑** and **↓** to change the setting.

Boosting sensitivity will show more information on your screen, which may cause clutter. Reducing sensitivity will filter out some information, but could omit important images. We recommend adjusting sensitivity until the background is lightly "peppered" — that is, scattered dots appear, but individual objects (like fish arches or bottom structure) can be easily picked out of the background.

5. Watch the display for the appearance of fish arches. When you see arches, you've found fish! Stop the boat and get your lure or bait into the water at the depth indicated on the sonar chart.

6. Gauge the fish depth by visually comparing the fish arches with the depth scale on the right side of the screen, or get a more accurate measure with the Depth Cursor. Press **MENU|↓** to **DEPTH CURSOR|ENT**. Press **↓** (or **↑**) to align the cursor line with the fish arch. The exact depth appears in a box at the right end of the cursor line. To clear the cursor, press **EXIT**.

7. If you are drifting at a very low speed or anchored, you are not moving fast enough for a fish to return the tell-tale fish arch signal. As you drift over a fish, or as a fish swims through the transducer's signal cone, the fish echo will appear as a straight line suspended between the surface and the bottom.

8. To turn off the unit, press and hold **PWR** key for three seconds.

Sonar Operations

As you can see from the quick reference on the previous page, basic operation is pretty easy, right out of the box. If you are a sonar novice, try operating the unit with the factory defaults until you get a feel for how it's working.

As you're learning the basics, there is one setting you might want to tinker with from time to time — Sensitivity.

Sensitivity controls the unit's ability to pick up echoes. If you want to see more detail, try increasing the sensitivity, a little at a time. There are situations when too much clutter appears on the screen. Decreasing the sensitivity can reduce the clutter and show the strongest fish echoes, if fish are present. As you change the sensitivity setting, you can see the difference on the chart as it scrolls.

Fig. 1

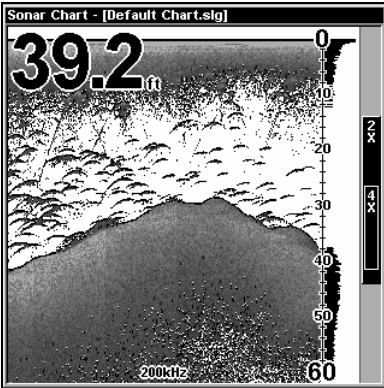

Fig. 2

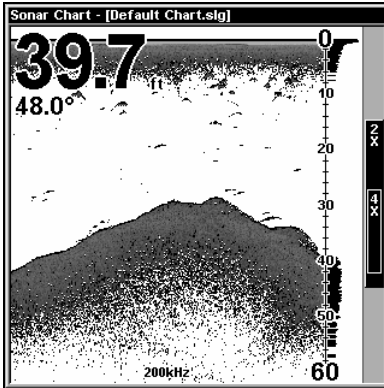

Fig. 3

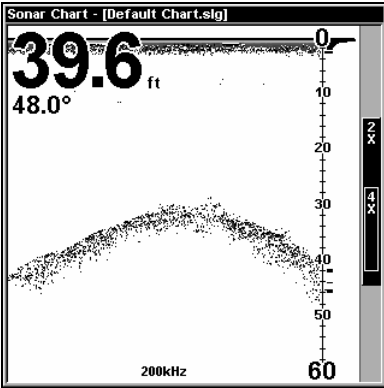
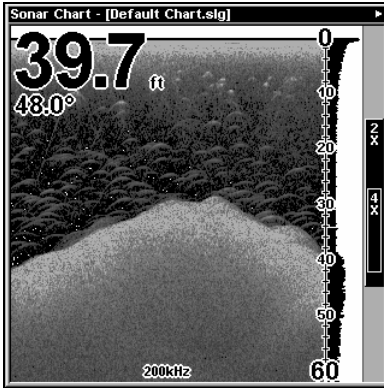

Fig. 4



These figures show results of different sensitivity levels on the same location. Fig. 1: Sensitivity at 88 percent, determined by Auto Sensitivity. Typical of full auto mode. Fig. 2: Sensitivity set at 75 percent. Fig. 3: Sensitivity set at 50 percent. Fig. 4: Sensitivity set at 100 percent.

You can change the sensitivity level whether you are in Auto Sensitivity mode or Manual Sensitivity mode. The adjustment method works the same in both modes, but it gives you slightly different results.

Adjusting sensitivity in Auto Sensitivity Mode is similar to manually adjusting a car's speed with the accelerator pedal while cruise control is on. You can tell the car to run faster, but when you let off the gas the cruise control *automatically* keeps you from running slower than the minimum speed setting. In the sonar unit, auto mode will let you increase sensitivity to 100 percent, but the unit will *limit* your *minimum* setting. This prevents you from turning sensitivity down too low to allow automatic bottom tracking. When you change the setting with auto turned on, the unit will continue to track the bottom and make minor adjustments to the sensitivity level, with a bias toward the setting you selected.

Adjusting sensitivity in Manual Sensitivity Mode is similar to driving a car without cruise control — you have *complete* manual control of the car's speed. In the sonar unit, manual mode allows you to set sensitivity at 100 percent (maximum) or zero percent (minimum.) Depending on water conditions, the bottom signal may completely disappear from the screen when you reduce sensitivity to about 50 percent or less!

Try adjusting sensitivity in both auto and manual modes to see how they work.

To adjust sensitivity

1. Press **MENU | ENT**.
2. The Sensitivity Control Bar appears. Press ↓ to decrease sensitivity; press ↑ to increase sensitivity. When it's set at the desired level, press **EXIT**. (When you reach the maximum or minimum limit, a tone sounds.)

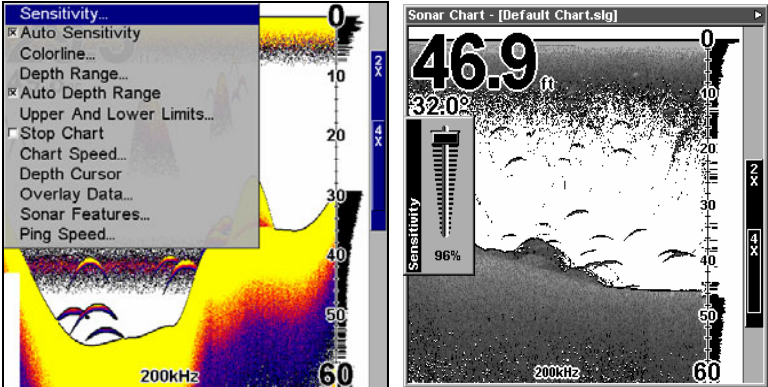

Sonar Menu with Sensitivity command selected (left). The Sensitivity Control Bar (right).

NOTE:

If you want to change the sensitivity in Manual Mode, first turn off Auto Sensitivity: from the Sonar Page, press **MENU** | ↓ to **AUTO SENSITIVITY** | **ENT** | ↑ to **SENSITIVITY** | **ENT**. Press ↓ or ↑ to pick a different sensitivity setting. When it's set at the desired level, press **EXIT**.

Important Tip:

While you are experimenting and learning, it's possible to scramble the settings so that the sonar picture disappears from your screen. If that happens, remember that it's easy to switch back to full automatic operation by simply restoring the factory auto settings. Here's how:

To Restore Factory Settings

1. Press **MENU** | **MENU** | ↓ to **RESET OPTIONS** | **ENT**.
2. The unit asks if you want to reset all the options. Press ← to **YES** | **ENT**. All options are reset, and the unit reverts back to the original settings.

Fish Symbols vs. Full Sonar Chart

You may have noticed in the quick reference that we used fish arches in full sonar chart mode for our example, and not the popular Fish I.D.[™] fish symbol feature. Here's why.

Fish I.D. *is* an easier way for a sonar novice to recognize a fishy signal return when he sees it. However, locating fish by symbol *only* has some limitations.

Your sonar unit's microprocessor is remarkably powerful, but it can be fooled. Some of the echoes *calculated* to be fish could be tree limbs or turtles! *To see what's under your boat in maximum detail, we recommend you turn off Fish I.D. and begin learning to interpret fish arches.*

Fish I.D. is most handy when you're in another part of the boat or performing some task that prevents you from watching the sonar screen. Then, you can turn on Fish I.D. and the audible fish alarm. When that lunker swims under your boat, you'll hear it!

Fish I.D. can also be useful when you want to screen out some of the sonar detail gathered by your unit. For example, in one case fishermen in San Francisco Bay saw clouds of clutter in the water but no fish arches. When a down rigger was pulled up, it brought up several small jellyfish. The fishermen switched their Lowrance sonar to Fish I.D., which screened out the schools of jellyfish and clearly showed the game fish there as fish symbols.

Other Free Training Aids

The sonar options section discusses Fish I.D., fish alarms and other features in greater detail. If you or a friend has Internet access, you can also learn more about interpreting what you see on your sonar screen. Visit our web site, **WWW.LOWRANCE.COM**. Be sure to check out the free Sonar Tutorial, which includes animated illustrations and more pictures of actual sonar returns, all described in detail. There's even a "printer friendly" version of the tutorial available on our web site...it makes a great supplement to this operation manual!

For the ultimate training aid, be sure to download the free emulator software for your unit. Aside from being just plain fun, this program can help you learn both basic and advanced operations without burning boat fuel! Lowrance is the first sonar manufacturer to provide this type of training tool for customers.

This PC application simulates the actual sonar unit on your computer. You can run it from your computer keyboard or use your mouse to press the virtual keys. Easy download and installation instructions are available on our web site.



Free training emulator is available for your unit on our web site.

Section 4: Sonar Options & Other Features

ASP™ (Advanced Signal Processing)

The ASP™ feature is a noise rejection system built into the sonar unit that constantly evaluates the effects of boat speed, water conditions and interference. This automatic feature gives you the best display possible under most conditions.

The ASP feature is an effective tool in combating noise. In sonar terms, noise is any undesired signal. It is caused by electrical and mechanical sources such as bilge pumps, engine ignition systems and wiring, air bubbles passing over the face of the transducer, even vibration from the engine. In all cases, noise can produce unwanted marks on the display.

The ASP feature has four settings — Off, Low, Medium and High. If you have high noise levels, try using the "High" ASP setting. However, if you are having trouble with noise, we suggest that you take steps to find the interference source and fix it, rather than continually using the unit with the high ASP setting.

There are times when you may want to turn the ASP feature off. This allows you to view all incoming echoes before they are processed by the ASP feature.

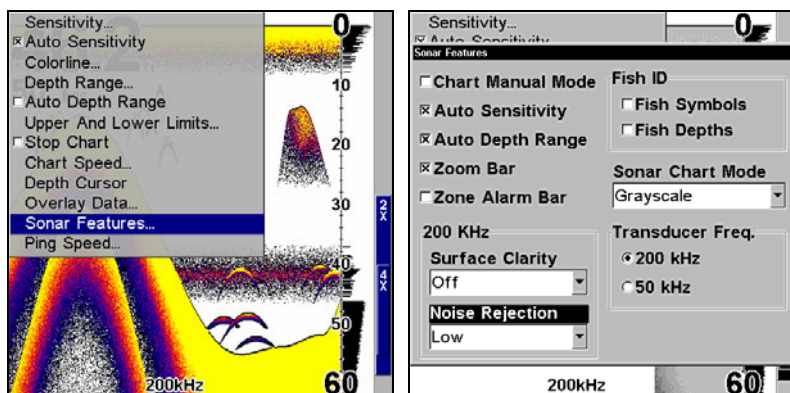

Sonar Menu with Sonar Features selected (left). Sonar Features menu (center) with Noise Rejection set to the default low setting. (Note the Transducer Frequency segment of the Sonar Features menu will not be present in the single frequency X-510c.)

To change the ASP level

1. From the Sonar Page, press **MENU** | ↓ to **SONAR FEATURES** | **ENT**.
2. Press ↓ to **NOISE REJECTION** | **ENT**.

3. Press \downarrow or \uparrow to select a setting, then press **ENT**.
4. To return to the previous page, press **EXIT | EXIT**.

Alarms

This unit has three different types of sonar alarms. The first is the Fish Alarm. It sounds when the Fish I.D.TM feature determines that an echo is a fish.

Another alarm is the Zone Alarm, which consists of a bar on the side of the screen. Any echo on the chart that appears inside this bar triggers this alarm.

The last alarm is the Depth Alarm, which has both a Shallow and a Deep setting. Only the bottom signal will trigger this alarm. This is useful as an anchor watch, a shallow water alert or for navigation.

Depth Alarms

The depth alarms sound a tone when the bottom signal goes shallower than the shallow alarm's setting or deeper than the deep alarm's setting. For example, if you set the shallow alarm to 10 feet, the alarm will sound a tone if the bottom signal is less than 10 feet. It will continue to sound until the bottom goes deeper than 10 feet.

The deep alarm works just the opposite. It sounds a warning tone if the bottom depth goes deeper than the alarm's setting. Both depth alarms work only off the digital bottom depth signals. No other targets will trip these alarms. These alarms can be used at the same time or individually.

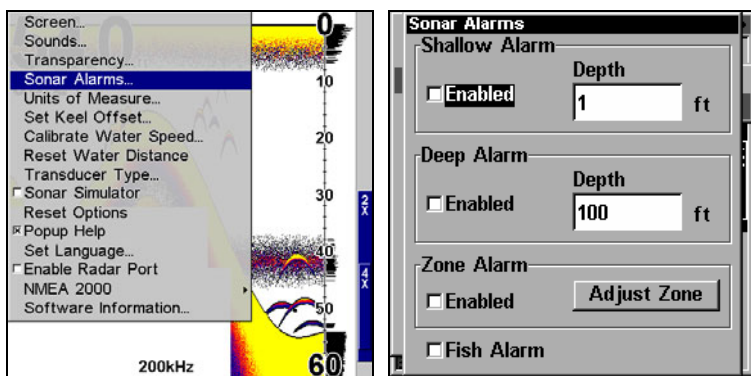

Main Menu with Sonar Alarms command highlighted (left).
Sonar Alarms menu (right).

To adjust and turn on the shallow alarm

1. Press the **ALARM** key on the front of the unit or press **MENU | MENU** and use \uparrow or \downarrow to select Sonar Alarms, then press **ENT**.
2. Press \rightarrow to **SHALLOW ALARM DEPTH | ENT**.

3. Press \uparrow or \downarrow to change the first number, then press \rightarrow to move the cursor to the next number and repeat until the depth is correct, then press **ENT**.

4. Press \leftarrow to **SHALLOW ALARM ENABLED | ENT | EXIT**.

5. To turn off the alarm, press **ALARM | ENT | EXIT**.

To switch to a different depth setting, open the Sonar Alarms menu and repeat the instructions in step 3 above.

To adjust and turn on the deep alarm

1. . Press the **ALARM** key on the front of the unit or press **MENU | MENU** and use \uparrow or \downarrow to select Sonar Alarms, then press **ENT**.

2. Press \downarrow to **DEEP ALARM ENABLED | \rightarrow to DEEP ALARM DEPTH | ENT**.

3. Press \uparrow or \downarrow to change the first number, then press \rightarrow to move the cursor to the next number and repeat until the depth is correct, then press **ENT**.

4. Press \leftarrow to **DEEP ALARM ENABLED | ENT | EXIT**.

5. To turn off the alarm, Press the **ALARM** key on the front of the unit or press **MENU | MENU** and use \uparrow or \downarrow to select Sonar Alarms, then press **ENT**. Press \downarrow to **DEEP ALARM ENABLED | ENT | EXIT**.

To switch to a different depth setting, open the Sonar Alarms menu and repeat the instructions in step 3 above.

Zone Alarm

The zone alarm is triggered when any echo passes inside the zone alarm bar, shown on the right side of the screen.

To adjust and turn on the zone alarm

1. Press the **ALARM** key on the front of the unit or press **MENU | MENU** and use \uparrow or \downarrow to select Sonar Alarms, then press **ENT**.

2. Press \downarrow to **ZONE ALARM ENABLED | \rightarrow to ADJUST ZONE | ENT**.

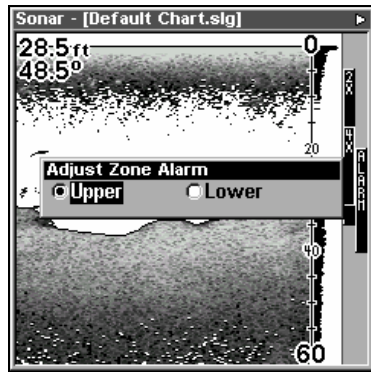
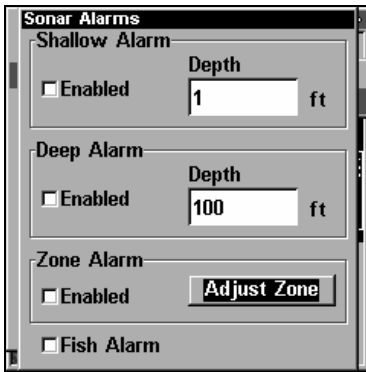

Sonar Alarms menu (left) with Adjust Zone command selected.
Adjust Zone Alarm selection box (right) with Upper selected.

3. To set the upper boundary for the Zone Alarm, use ← or → to select **UPPER**, then press ↑ or ↓ to move the top of the bar to the desired depth.
4. To set the lower boundary for the Zone Alarm, use ← or → to select **LOWER**, then press ↑ or ↓ to move the bottom of the bar to the desired depth.
5. Press **EXIT|←** to **ZONE ALARM ENABLED|ENT|EXIT**. Now, any echo — fish, bottom, structure — within the zone alarm's depth range will trigger the zone alarm.
6. To turn off the alarm Press the **ALARM** key on the front of the unit or press **MENU|MENU** and use ↑ or ↓ to select Sonar Alarms, then press **ENT**. Press ↓ to **ZONE ALARM ENABLED|ENT|EXIT**.

To switch to a different depth setting, open the Sonar Alarms menu and repeat the instructions in steps 3 and 4 above.

Fish Alarm

Use the fish alarm for a distinctive audible alarm when fish or other suspended objects are detected by the Fish I.D.[™] feature (Fish I.D. must be turned on for the Fish Alarm to work). a different tone sounds for each fish symbol size shown on the display.

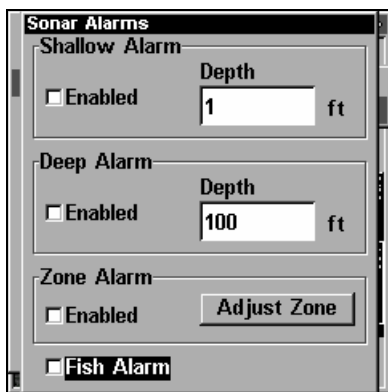

Sonar Alarms menu with Fish Alarm selected. The check box to the left is blank, indicating the alarm is turned off.

To turn the fish alarm on

1. Press the **ALARM** key on the front of the unit or press **MENU | MENU** and use \uparrow or \downarrow to select Sonar Alarms, then press **ENT**.
2. Press \downarrow to **FISH ALARM | ENT | EXIT**.
3. To turn off the alarm, Press the **ALARM** key on the front of the unit or press **MENU | MENU** and use \uparrow or \downarrow to select Sonar Alarms, then press **ENT**. Press \downarrow to **FISH ALARM | ENT | EXIT**.

Brightness

See the entry in this section for Screen Contrast and Brightness.

Calibrate Speed

The speed sensor can be calibrated to compensate for inaccuracies. Before you change the setting, first calculate the percentage that the speed is off. You will enter this percentage in a moment.

For example, if you figure the sensor is reading 10 percent faster than actual speed, you will enter $- 10$ in the calibration window. If the sensor is reading 5 percent slower than true speed, you will enter $+ 5$ in the window.

Perform your test in relatively calm water free of current, if possible. (Unless, of course, you are taking the current speed into consideration when making your calculation.) After you have a correction figure, here's how to enter it:

1. Press **MENU | MENU | \downarrow** to **CALIBRATE WATER SPEED | ENT**.
2. Enter the number you calculated earlier: press \uparrow or \downarrow to change the first character ($+$ or $-$), then press \rightarrow to move the cursor to the next number and repeat until the percentage is correct, then press **EXIT**.

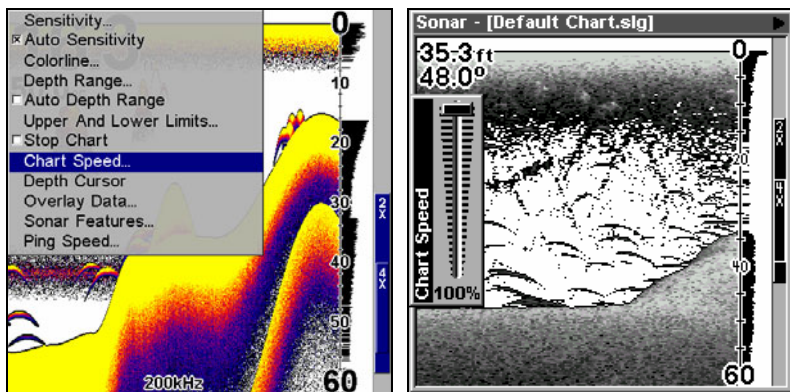

Sonar Page menu with Chart Speed command selected (left).
Chart Speed Control Bar (right).

Chart Speed

The rate that echoes scroll across the screen is called the chart speed. The default is maximum; we recommend that you leave the speed set there for virtually all fishing conditions.

However, you might consider experimenting with chart speed when you are stationary or drifting very slowly. You may sometimes achieve better images as you slow down the chart speed to match how fast you are moving across the bottom.

If you are at anchor, ice fishing or fishing from a dock, experiment with a chart speed around 50 percent. If you are drifting slowly, try a chart speed around 75 percent. When you are stationary and a fish swims through the sonar signal cone, the image appears on the screen as a long line instead of a fish arch. Reducing the chart speed may result in a shorter line that more closely resembles a regular fish return.

If you do experiment with chart speed, remember to reset it to maximum when you resume trolling or moving across the water at higher speed. To change chart speed:

1. From the Sonar Page, press **MENU** | ↓ to **CHART SPEED** | **ENT**.
2. The Chart Speed Control Bar appears. Press ↓ to decrease chart speed; press ↑ to increase chart speed.
3. When it's set at the desired level, press **EXIT**.

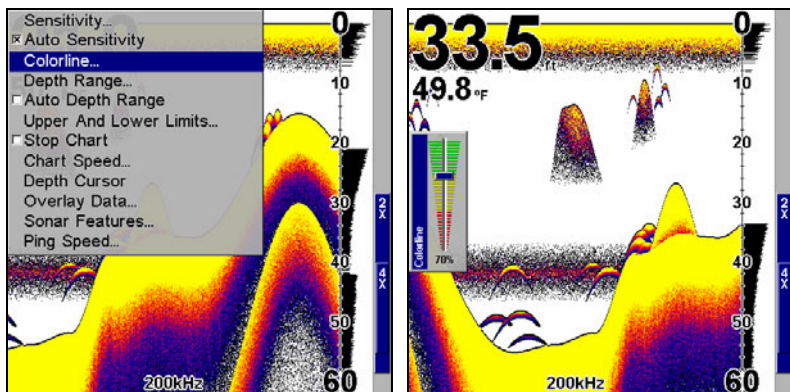

Sonar Page menu with ColorLine command selected (left).
The ColorLine control bar (right).

Colorline

lets you distinguish between strong and weak echoes. It "paints" a brighter color on targets that are stronger than a preset value. This allows you to tell the difference between a hard and soft bottom. For example, a soft, muddy or weedy bottom returns a weaker signal which is shown with a narrow, colored line (dark blue tinged with red or a little yellow.) Since fish are among the weakest echoes, they show up mostly as blue arches. A hard bottom or other relatively hard target returns a strong signal which causes a wider brightly colored line (red-dish yellow to bright yellow.)

If you have two signals of equal size, one with red to yellow color and the other without, then the target with brighter color (yellow) is the stronger signal. This helps distinguish weeds from trees on the bottom, or fish from structure.

ColorLine is adjustable. Experiment with your unit to find the Color-Line setting that's best for you.

To adjust the Colorline level

1. From the Sonar Page, press **MENU** | ↓ to **COLORLINE** | **ENT**.
2. The Colorline Control Bar appears. Press ↓ to decrease Colorline; press ↑ to increase Colorline.
3. When it's set at the desired level, press **EXIT**.

Contrast

See the entry in this section for Screen Contrast and Brightness.

Depth Cursor

The depth cursor consists of a horizontal line with a digital depth box on the right side. The numbers inside the box show the depth of the cursor.

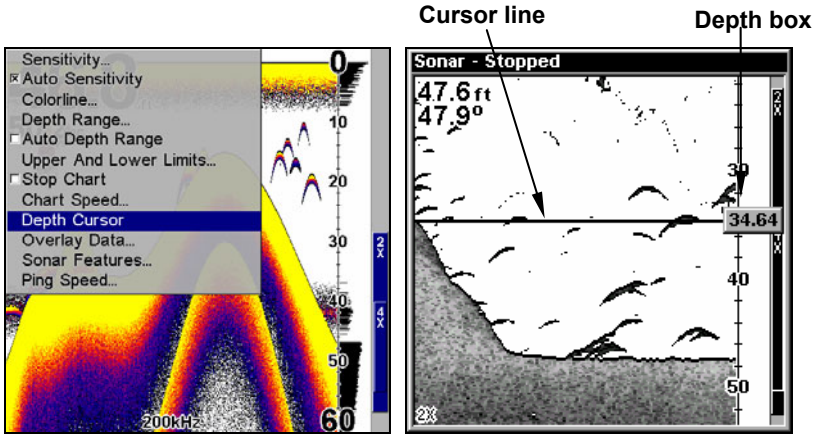

Sonar Page menu with Depth Cursor selected (left). Sonar chart with the depth cursor active (right). The cursor is 34.64 feet deep.

The cursor can be moved to any location on the screen, letting you pinpoint the depth of a target.

1. From the Sonar Page, press **MENU** | \downarrow to **DEPTH CURSOR** | **ENT**.
2. The depth cursor appears. Press \downarrow to lower the cursor line; press \uparrow to raise the cursor line.
3. To clear the depth cursor, press **EXIT**.

Depth Range - Automatic

When turned on for the first time, the bottom signal is automatically placed in the lower half of the screen. This is called Auto Ranging and is part of the automatic function. However, depending upon the bottom depth and the current range, you can change the range to a different depth.

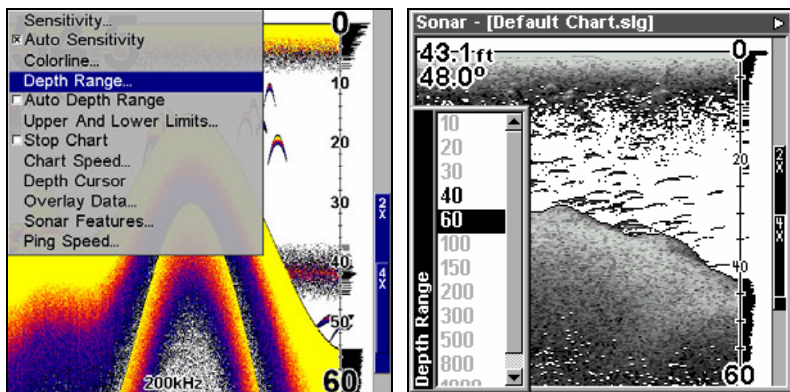

Sonar Page menu with Depth Range command selected (left). The Depth Range Control Scale (right).

1. From the Sonar Page, press **MENU** | ↓ to **DEPTH RANGE** | **ENT**.
2. The Depth Range Control Scale appears. Press ↑ or ↓ to select a different depth range. A blue bar highlights the selected range. Lightly shaded numbers can not be selected.
3. When the new range is selected, press **EXIT** to clear the menu.

Depth Range - Manual

You have complete control over the range when the unit is in the manual mode. There are 16 depth ranges, from 5 feet to 4,000 feet.

To switch to Manual Depth Range

1. First, turn off automatic depth range. From the Sonar Page, press **MENU** | ↓ to **AUTO DEPTH RANGE** | **ENT**.
2. Press ↑ to **DEPTH RANGE** | **ENT** and the Depth Range Control Scale appears.
3. Press ↓ or ↑ to select a different depth range. A horizontal blue bar highlights the selected range.
4. When the new range is selected, press **EXIT** to clear the menu.

To turn Auto Depth Range on again

1. From the Sonar Page, press **MENU** | ↓ to **AUTO DEPTH RANGE** | **ENT** | **EXIT**.

NOTE:

The sonar's depth capability depends on water and bottom conditions, transducer installation and other factors.

Depth Range - Upper and Lower Limits

Virtually any segment of the water column can be displayed by using the upper and lower limit feature. This lets you pick the deep and shal-

low depth limits that are shown on the screen, provided there is at least 10 feet between the upper and lower limits you select. For example, a range from 12 feet to 34 feet could be used.

Changing the upper and lower limits gives you far greater control over the depth range. This feature lets you "zoom in" the display with almost unlimited combinations. Nearly any segment of the water column, from the surface to the bottom can be shown. This enlarges the sonar targets to best suit your fishing needs and water conditions.

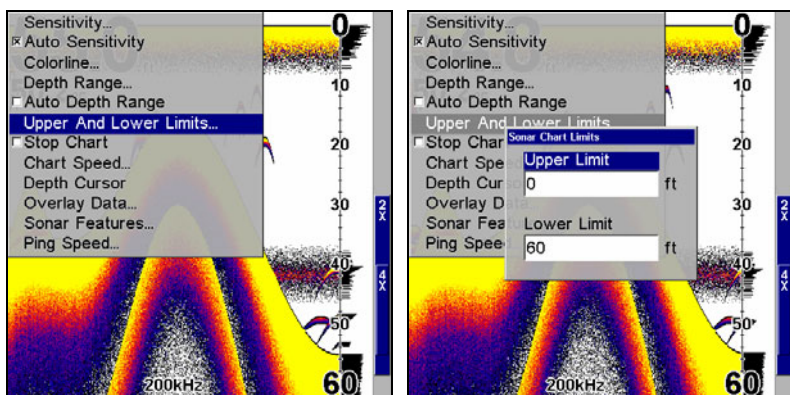

Sonar Page Menu with Upper and Lower Limits command selected (left). Sonar Chart Limits menu with Upper Limit selected (right).

To change the upper and lower limits

1. From the Sonar Page, press **MENU** | **↓** to **UPPER AND LOWER LIMITS** | **ENT**. The Sonar Chart Limits menu appears, with Upper Limit selected.
2. To set the upper limit, press **ENT**. Press **↑** or **↓** to change the first number, then press **→** to move the cursor to the next number and repeat until the depth is correct, then press **EXIT**.
3. To set the lower limit, press **↓** to **LOWER LIMIT** | **ENT**. Press **↑** or **↓** to change the first number, then press **→** to move the cursor to the next number and repeat until the depth is correct, then press **EXIT** repeatedly.

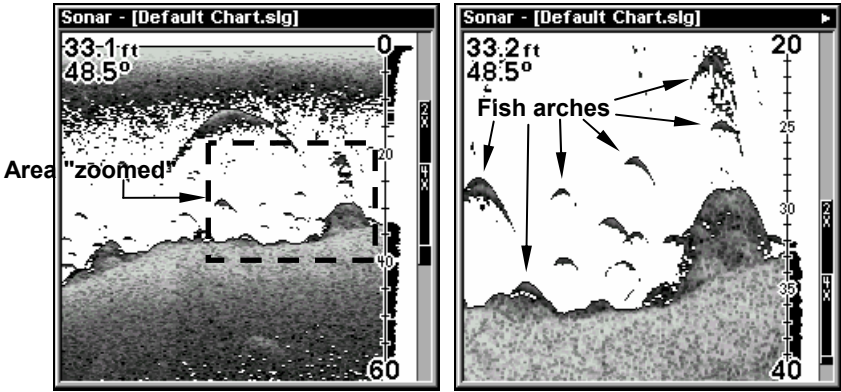

Normal display, in auto depth range mode (left). Display "zoomed" with Upper and Lower Limits focusing on the portion of the water column from 20 feet to 40 feet deep (right). In the "zoomed" image, note the target definition at lower left, showing a fish holding just above the structure. Top right, two game fish are attacking a school of bait fish.

To turn off upper and lower limits

1. From the Sonar Page, press **MENU** | ↓ to **AUTO DEPTH RANGE** | **ENT** | **EXIT**.

FasTrack™

This feature automatically converts all echoes to short horizontal lines on the display's far right side. The graph on the rest of the screen continues to operate normally. FasTrack gives you a rapid update of conditions directly under the boat. This makes it useful for ice fishing, or when you're fishing at anchor. When the boat is not moving, fish signals are long, drawn out lines on a normal chart display. FasTrack converts the graph to a vertical bar graph that, with practice, makes a useful addition to fishing at a stationary location.

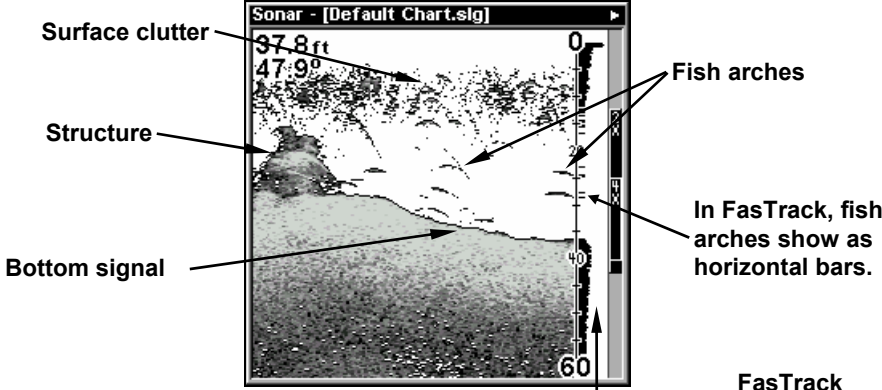

Sonar Page showing FasTrack.

FasTrack bar graph

Fish I.D.™ (Fish Symbols & Depths)

The Fish I.D. feature identifies targets that meet certain conditions as fish. The microcomputer analyses all echoes and eliminates surface clutter, thermoclines, and other signals that are undesirable. In most instances, remaining targets are fish. The Fish I.D. feature displays fish symbols on the screen in place of the actual fish echoes.

There are several fish symbol sizes. These are used to designate the relative size between targets. In other words, Fish I.D. displays a small fish symbol when it thinks a target is a small fish, a medium fish symbol on a larger target and so on.

The sonar's microcomputer is sophisticated, but it can be fooled. It can't distinguish between fish and other suspended objects such as trotlines, turtles, submerged floats, air bubbles, etc. Individual tree limbs extending outwards from a group of limbs is the hardest object for the Fish I.D. feature to distinguish from fish.

You may see fish symbols on the screen when actually, there are no fish. The reverse is also true. The illustrations on the next page show how Fish I.D. can actually *miss* fish that *are* present.

Does that mean Fish I.D. is broken? No — the feature is simply interpreting sonar returns in a specific way to help take some of the work out of reading the screen. Remember: Fish I.D. is one of the many tools we provide so you can analyze your sonar returns for maximum fish finding information. This and other features can help you successfully "see" beneath the boat under varied water and fishing conditions. So, practice with the unit in both the Fish I.D. mode and without to become more familiar with the feature. The default for Fish I.D. is off.

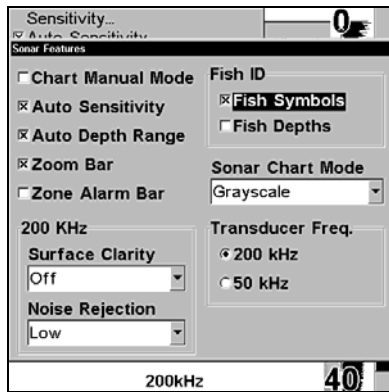

Sonar Features menu with Fish I.D. Symbols selected. When the check box to the left is checked, the feature is on.

Fig. 1A

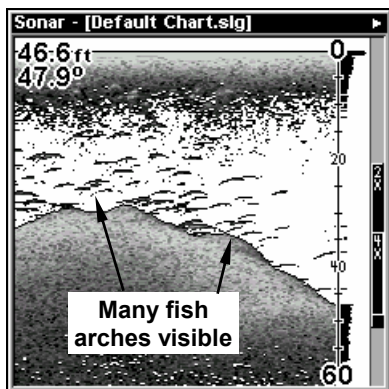

Fig. 2A

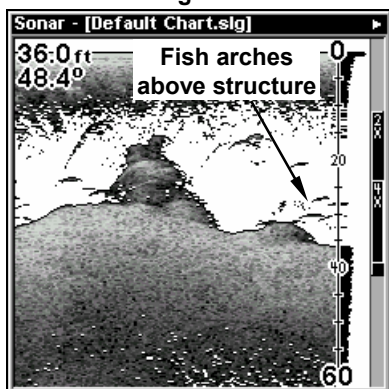

Fig. 1B

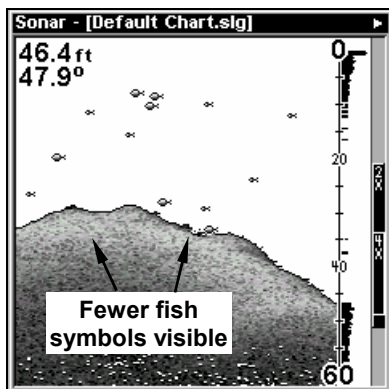
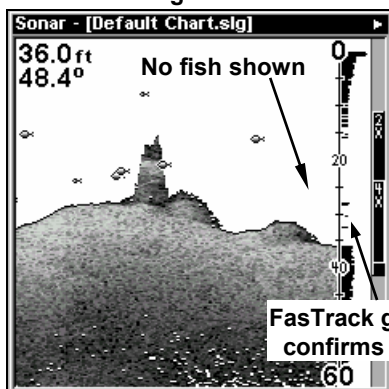

Fig. 2B



Figures 1A and 2A (left) show Sonar Page in normal chart mode. Figures 1B and 2B (right) show the same underwater scene with Fish I.D. turned on. Note how arches are replaced with symbols.

To turn the Fish I.D. feature on

1. From the Sonar Page, press **MENU** | ↓ to **SONAR FEATURES** | **ENT**.
2. Press → to **FISH SYMBOLS** | **ENT** | **EXIT** | **EXIT**.

To turn off Fish I.D., repeat the instructions in step 2.

FishTrack™

The FishTrack feature shows the depth of a fish symbol when it appears on the display. This lets you accurately gauge the depth of targets. This feature is available only when the Fish I.D. feature is on. The default setting for FishTrack is off.

To turn on FishTrack

1. From the Sonar Page, press **MENU** | ↓ to **SONAR FEATURES** | **ENT**.
2. Press → | then press ↓ to **FISH DEPTHS** | **ENT** | **EXIT** | **EXIT**.

NOTE

These instructions will turn on FishTrack and Fish I.D. at the same time.

To turn off FishTrack, repeat the instructions in step 2. Turning off FishTrack in this manner will not turn off Fish I.D. symbols.

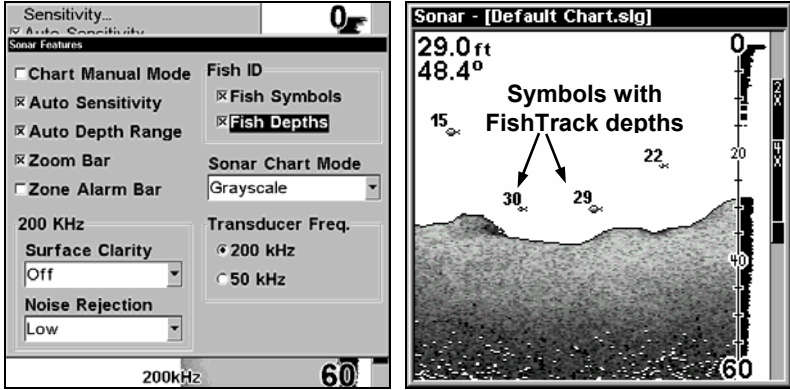

Sonar Features menu with Fish I.D. Depths selected (left). Sonar Page showing Fish I.D. symbols and FishTrack depths turned on (right).

**Frequency (Change Transducer Frequency)
(X-515cDF only)**

The "DF" in your unit's name refers to its dual-frequency transducer, which operates with both 200 kHz and 50 kHz. The 200 kHz frequency has a 12° cone angle and the 50 kHz frequency has a 35° cone angle.

The default frequency is 200 kHz, which is best for use in shallow water (about 300 feet or less). This frequency is the best choice for about 80 percent of the fresh and saltwater sport fishing applications. When you get into very deep saltwater – 300 to 500 feet or deeper – the 50 kHz frequency is the best choice.

The 200 kHz transducer will give you better detail and definition, but less depth penetration. The 50 kHz transducer will give you greater depth penetration, but a little less detail and less definition. (Remember, all sonar units typically read deeper in fresh water than in saltwater.)

There is a common exception to these rules. Some fishermen, who use downriggers on freshwater lakes (or the ocean), like to see their bait on the sonar. In many of those cases, you'll see a 50 kHz transducer frequency in use because the wider cone angle.

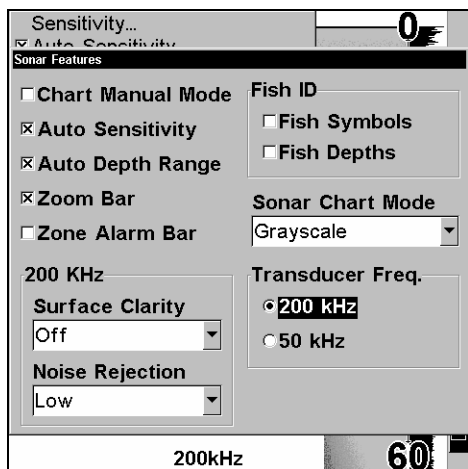

Sonar Features menu with a frequency of 200 kHz selected.

To change the frequency setting to 50 kHz

1. From the Sonar Page, press **MENU** | ↓ to **SONAR FEATURES** | **ENT**.
2. Press → | then press ↓ to **50 kHz** | **ENT**.
3. Press **EXIT** | **EXIT** to clear the menu.

To change the frequency setting to 200 kHz

1. From the Sonar Page, press **MENU** | ↓ to **SONAR FEATURES** | **ENT**.
2. Press → | then press ↓ to **200 kHz** | **ENT**.
3. Press **EXIT** | **EXIT** to clear the menu.

HyperScroll™

See the entry on Ping Speed, which controls the HyperScroll feature.

Noise Rejection

See the entry on Advanced Signal Processing in this section.

Overlay Data

To change the digital data shown on top of the sonar page:

1. Press **MENU** | ↓ to **OVERLAY DATA** | **ENT**.
2. Highlight (**PRESS ENT TO ADD...**) and press **ENT**.

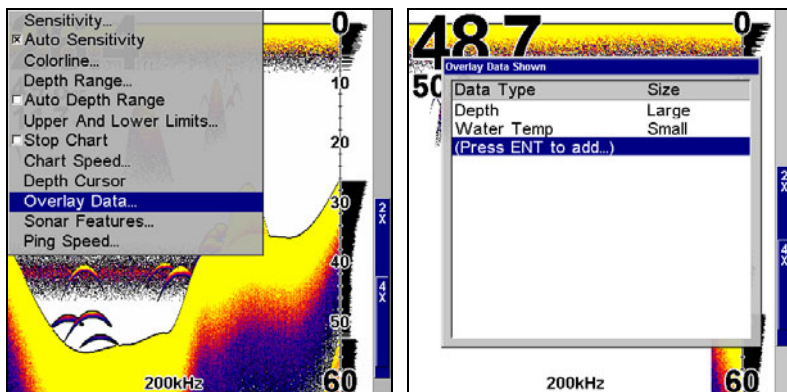

Overlay Data command on the Sonar Menu (left). Overlay Data Shown selection menu (right).

3. The Data Viewer page will appear with three data categories: Time, Sonar Data and Sensor Data.
4. Highlight the desired data category and press **ENT**, which will expand the list, revealing several subcategories with checkboxes next to them.
5. Select the desired subcategory and press **ENT**, which will place a checkmark in the checkbox, showing the selected data is set for display.

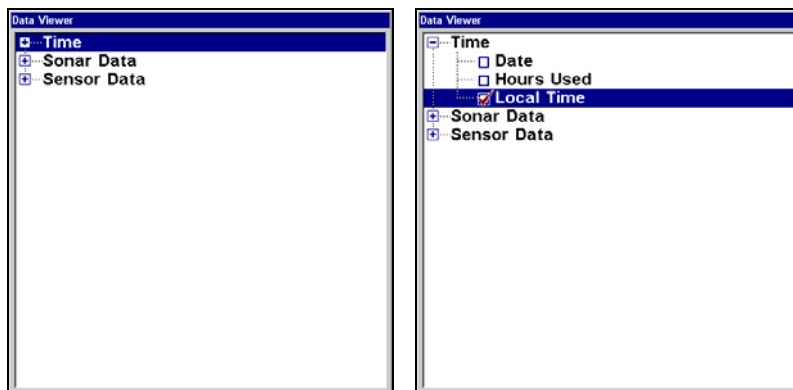

The Data Viewer menu with Time selected (left). Time-data categories are visible (right). Local Time is selected.

6. Press **EXIT** repeatedly to get back to the main display.

To change Overlay data size:

1. Press **MENU** | ↓ to **OVERLAY DATA** | **ENT**.
2. Highlight the *Data Type* you want to resize, then use ← → to set the data to the desired size to one of four options: Off, Small, Medium, Large and Enormous.

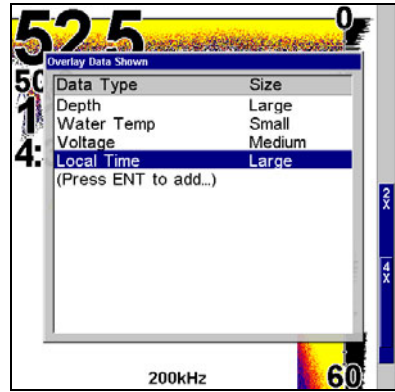
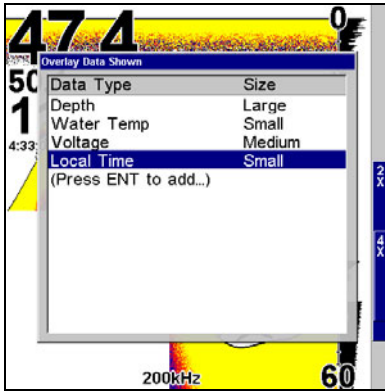

Local Time highlighted on Overlay Data Shown menu (left). The size of Local Time data has been changed to Large (right).

3. To change the font size for another Data Type, repeat the steps above. To return to the sonar display, press **EXIT**.

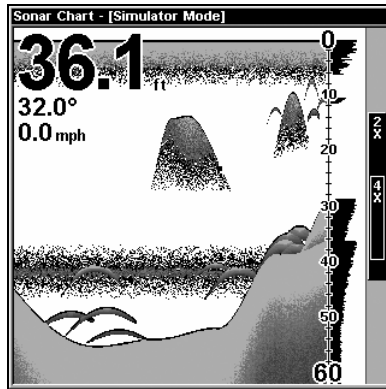

Sonar chart with Overlay Data turned on. This example shows Depth, Water Temperature and the Water Speed of the boat.

Ping Speed & HyperScroll™

Ping Speed controls the rate at which the transmitter and transducer broadcast sonar sound waves — pings — into the water. The unit has a default ping speed of 50 percent. At normal boating speeds, this automatically provides enough return echoes to refresh the screen and scroll the chart at maximum chart speed.

However, when you are running at high speeds, or just want the fastest possible screen update, you may want to use the HyperScroll™ feature. When you change the Ping Speed to any setting greater than 50 percent, the unit automatically enters HyperScroll mode.

These faster ping rates allow you to maintain a high-detail picture on the screen, and the screen refresh rate and chart scroll speed can keep pace with the boat as it moves quickly over the bottom terrain.

When using HyperScroll, you may also need to manually decrease the sensitivity for optimum performance. Depending on water depth and other conditions, HyperScroll may cause a second bottom echo to return to the transducer during the next ping cycle, or sounding. This can result in a large amount of clutter appearing on the screen. If this occurs, just decrease the sensitivity to a level that eliminates the clutter. When you turn HyperScroll off, you can return to your original sensitivity level.

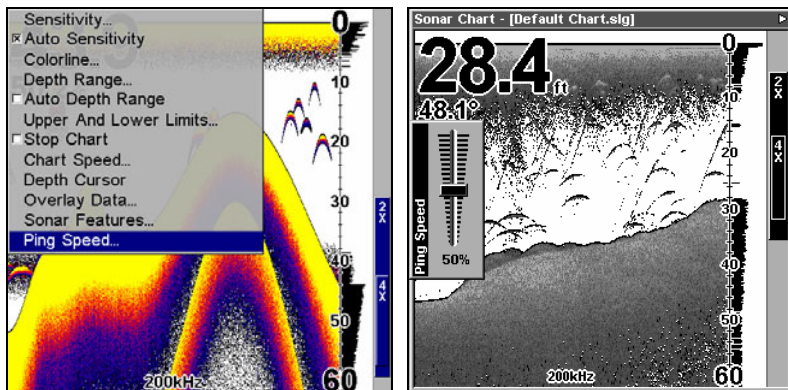

Sonar Menu with Ping Speed command selected (left).
Ping Speed Control Bar (right) at default setting.

To change Ping Speed

1. From the Sonar Page, press **MENU** | ↓ to **PING SPEED** | **ENT**.
2. The Ping Speed Control Bar appears. Press ↑ to increase ping speed. Press ↓ to decrease ping speed. When it's set at the desired level, press **EXIT**.

To adjust Sensitivity

1. From the Sonar Page, press **MENU** | **ENT**.
2. The Sensitivity Control Bar appears. Press ↓ to decrease sensitivity; press ↑ to increase sensitivity. When it's set at the desired level, press **EXIT**. (When you reach the maximum or minimum limit, a tone sounds.)

To turn off HyperScroll

1. From the Sonar Page, press **MENU** | ↓ to **PING SPEED** | **ENT**.
2. The Ping Speed Control Bar appears. Press ↓ to decrease ping speed to 50 percent. When it's set at the desired level, press **EXIT**.

When you boost ping speed and switch into HyperScroll, the width of the FasTrack bar graph display doubles in width at the right side of the screen. This allows you to better see the virtually instantaneous sonar returns, just as you would on a flasher sonar unit. For more information on FasTrack, see its entry in this section.

Pop-up Help

Help is available for virtually all of the menu labels on this unit. By highlighting a menu item and leaving it highlighted for a few seconds, a "pop-up" message appears that describes the function of the menu item. This feature is on by default.

To set up Pop-up Help: Press **MENU | MENU | ↓** to **POPUP HELP**. With the option highlighted, press **ENT** to check it (turn on) and uncheck it (turn off.) After the option is set, press **EXIT** to return to the page display.

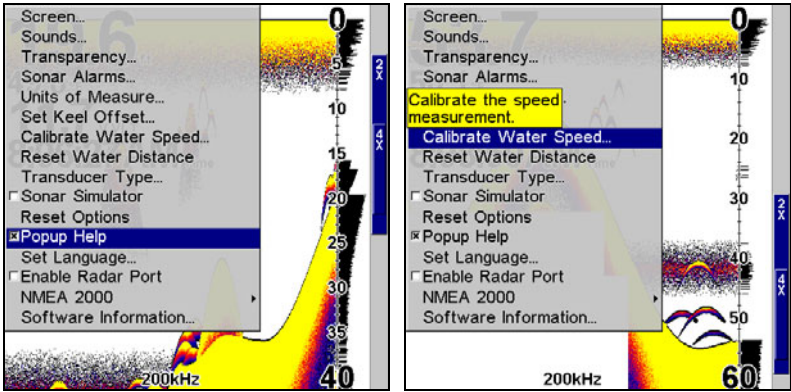

Main Menu with Pop-up Help command highlighted (left). Pop-up Help message for the Calibrate Water Speed command (right).

Reset Options

This command is used to reset all features, options and settings to their original factory defaults. This is useful when you have changed several settings and want to return to basic automatic operation.

1. Press **MENU | MENU | ↓** to **RESET OPTIONS | ENT**.
2. Press **←** to **YES | ENT**.
3. All the menus are cleared and all options are returned to the factory settings.

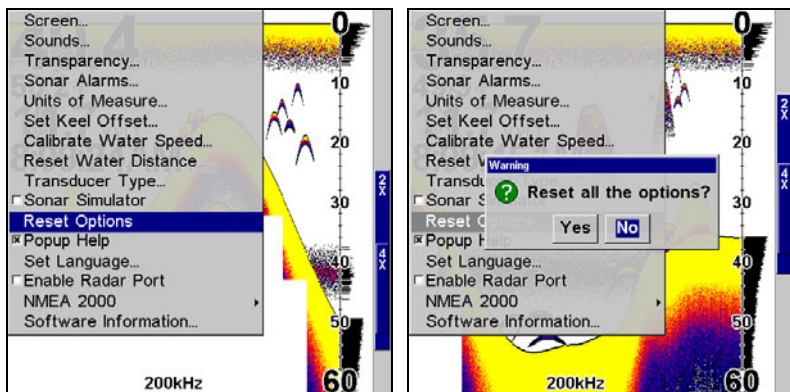

Main Menu with Reset Options command selected (left). The Reset Options dialog box, with "Yes" selected (right).

Reset Water Distance

The sonar chart's Digital Data display option includes a window that shows distance traveled, called Water Distance ("W Distance"). This information is calculated from an optional water speed sensor. The Water Distance window can be reset to zero using the Reset Water Distance command.

Press **MENU | MENU | ↓** to **RESET WATER DISTANCE | ENT**. The menus are cleared and the water distance is reset to 0.00.

Screen Contrast and Brightness

To access the Screen menu, press **MENU | MENU | ENT**.

Adjusting the display's contrast

The **CONTRAST** slider bar is already selected. Press **→** or **←** to move the bar. The left end of the scale is minimum contrast; the right end is maximum contrast.

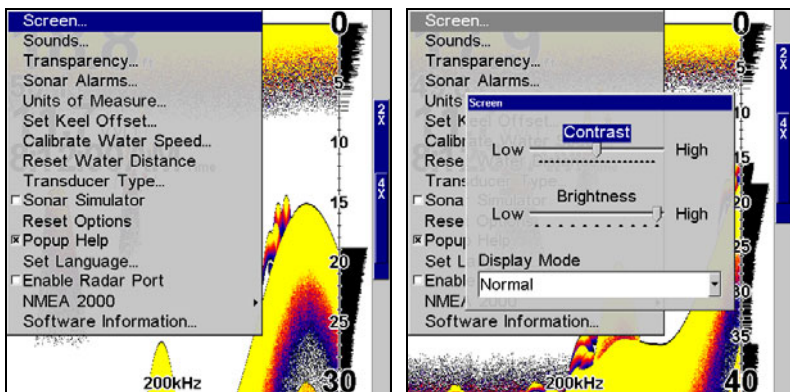

Screen Command (left). Screen Menu with Contrast bar selected (right).

To adjust the display's brightness:

Press ↓ to **BRIGHTNESS**. Press → or ← to move the bar. The left end of the scale is minimum contrast; the right end is maximum contrast.

To adjust the screen's display mode:

Press ↓ to **DISPLAY MODE | ENT |** press ↑ or ↓ to select *mode* | **EXIT**.

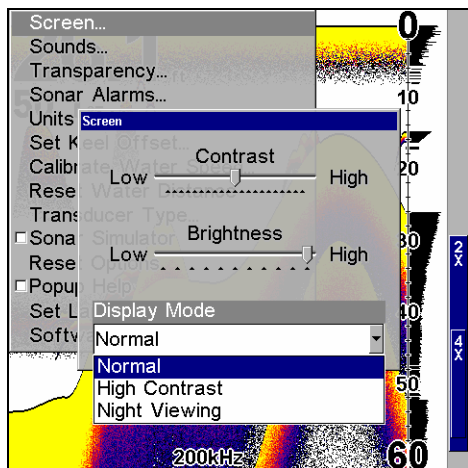

Display Mode menu.

Sensitivity & Auto Sensitivity

The sensitivity controls the ability of the unit to pick up echoes. Sensitivity can be adjusted, because water conditions vary greatly. A low sensitivity level (from zero to 50 percent) excludes much of the bottom information, fish signals, and other target information.

High sensitivity levels let you see this detail, but it can also clutter the screen with many undesired signals.

Typically, the best sensitivity level shows a good solid bottom signal with some surface clutter.

Automatic Sensitivity

The default sensitivity mode is automatic. The unit bases the sensitivity level on water depth and conditions. When the unit is in the automatic mode, sensitivity is automatically adjusted to keep a solid bottom signal displayed, plus a little more power. This gives it the capability to show fish and other detail.

However, situations occur when it becomes necessary to increase or decrease the sensitivity. This typically happens when you wish to see more detail or when wave action and boat wakes create enough tiny air bubbles to clutter much of the water column. In that case, a decrease in sensitivity is indicated to reduce some of the clutter.

The control bar used to adjust sensitivity is the same whether the unit is in the automatic or manual mode. In automatic you can adjust sensitivity up to 100 percent but the unit will limit your *minimum* setting. In auto, the unit will continue to make small adjustments, allowing for the setting you selected.

In manual mode, you have *complete* control over sensitivity, with the ability to set it anywhere from zero to 100 percent. Once you select a level in manual, the unit will continue to use that exact sensitivity setting until you change it or revert to auto mode.

To adjust sensitivity in auto mode:

1. Press **MENU | ENT**.
2. The Sensitivity Control Bar appears. Press ↓ to decrease sensitivity; press ↑ to increase sensitivity. When it's set at the desired level, press **EXIT**. (When you reach the maximum or minimum limit, a tone sounds.)

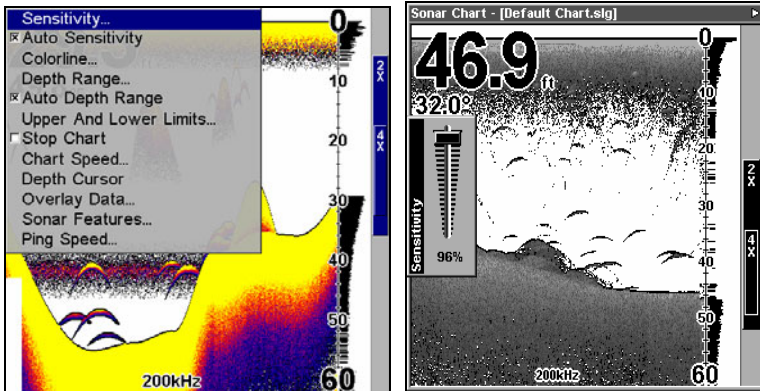

Sonar Menu with Sensitivity command selected (left). The Sensitivity Control Bar (right).

To adjust sensitivity in manual mode

1. First, turn off Auto Sensitivity: from the Sonar Page, press **MENU** | **↓** to **AUTO SENSITIVITY** | **ENT**.
2. Press **↑** to **SENSITIVITY** | **ENT** and the Sensitivity Control Bar appears. Press **↓** or **↑** to pick a different sensitivity setting. When it's set at the desired level, press **EXIT**. Repeat these steps to turn on Auto Sensitivity.

NOTE:

To return to the original factory setting for Auto Sensitivity, see the entry in this section on Reset Options. If sensitivity is in manual mode, the Reset Options command will switch back to Auto and reset the factory setting at the same time.

Tip:

For quicker sensitivity adjustments, try leaving the Sensitivity Control Bar on the screen as the chart scrolls. You can see the changes on the screen as you press the up or down arrows. This is handy when there's a lot of clutter in the water, and you are matching the sensitivity to rapidly changing water conditions.

Set Keel Offset

This unit measures water depth from the face of the transducer. Since the transducer is installed below the water surface, the distance displayed by the digital depth, chart depth scale, chart cursor or fish symbols is *not* the exact water depth. If the transducer is 1 foot below the surface, and the screen shows the water depth as 30 feet, then the actual depth is 31 feet. On sailboats or other large vessels with deep drafts, the distance between the transducer installation and the keel or

lower engine unit can be several feet. In those cases, an inexact depth reading could result in grounding or striking underwater structure. The Keel Offset feature eliminates the need for the navigator to mentally calculate how much water is under his keel.

Keel Offset lets you calibrate the digital depth: chart depth scale, chart cursor depth and fish symbol depth displayed on the screen. To calibrate the depth indicators, first measure the distance from the face of the transducer to the lowest part of the boat. In this example, we will use 3.5 feet. We enter this as a *negative* 3.5 feet, which makes the depth indicators perform as if the transducer's lower in the water than it really is.

1. Press **MENU | MENU | ↓** to **SET KEEL OFFSET | ENT**.
2. The Keel Offset dialog box appears. Press **↓** to change the plus (+) sign to a minus (-) sign.
3. Press **→** to the first number, then press **↑** to change the number to 3
4. Press **→** to the second number, then press **↑** to change the number to 5, then press **EXIT**. The depth indicators now accurately show the depth of water beneath the keel.

NOTE:

If knowing the exact depth of water beneath the keel is less important, you can calibrate the depth indicators so that they show the actual water depth from surface to bottom. To do this, first measure the distance from the face of the transducer up to the surface (the water line on the boat). In this example, we will use 1.5 feet. This will be entered as a *positive* 1.5 feet, which makes the depth indicators perform as if the transducer's higher in the water than it really is.

1. Press **MENU | MENU | ↓** to **SET KEEL OFFSET | ENT**.
2. The Keel Offset dialog box appears with a plus (+) sign at the front of the box.
3. Press **→** to the first number, then **↑** to change the number to 1.
4. Press **→** to the second number, then **↑** to change the number to 5. Press **EXIT** to return to the previous page. The depth indicators now accurately show the water depth from surface to bottom.

Set Language

This unit's menus are available in 10 languages: English, French, German, Spanish, Italian, Danish, Swedish, Russian, Dutch and Finnish.

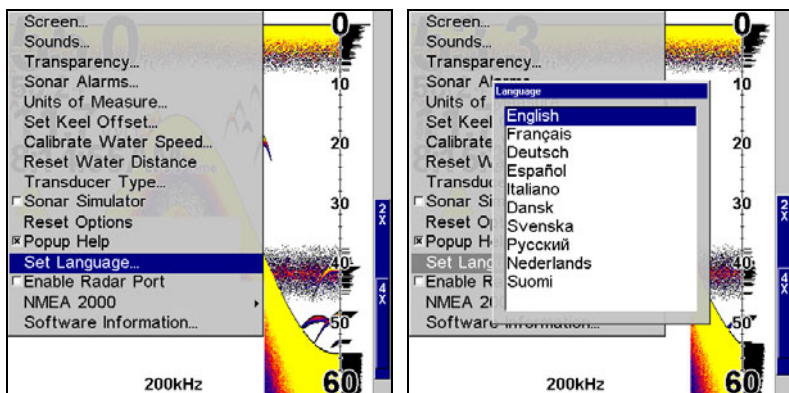

Set Language selected on main menu (left). Language menu (right).

To select a different language:

1. Press **MENU | MENU | ↓** to **SET LANGUAGE | ENT**.
2. Use **↓** or **↑** to select a different language and press **ENT | EXIT**. All menus now appear in the language you selected.

Software Version Information

From time to time, Lowrance updates the operating system software in some of its products. These software upgrades are usually offered to customers as free downloads from our web site, www.lowrance.com. These upgrades make the unit perform better or introduce a new feature or function. You can find out what software version is running in your sonar unit by using the Software Information command.

To view software information:

1. Press **MENU | MENU | ↓** to **SOFTWARE INFO | ENT**.
2. Read the information displayed on the screen.
3. To return to the last page displayed, press **EXIT | EXIT**.

Sonar Chart Mode

The default color scheme for the sonar chart is a white background, but we offer several other options to suit your viewing preferences. You can select the chart to be displayed in Grayscale, Reverse Grayscale, Blue Background, White Background, Nightview, IceView and Bottom Color Tracking.

To change the chart mode color scheme

1. From the Sonar Page, press **MENU | ↓** to **SONAR FEATURES | ENT**.
2. Press **→** then, **↓** to **SONAR CHART MODE | ENT**.

3. Press ↓ or ↑ to *Mode Name* | **ENT**.
4. Press **EXIT** | **EXIT** to return to the Sonar Page.

Sonar Chart Display Options

The Pages Menu offers five chart display options for dual-frequency models and four options for single-frequency models. To access them, press **PAGES** | ↓ to *Option Name* | **EXIT**.

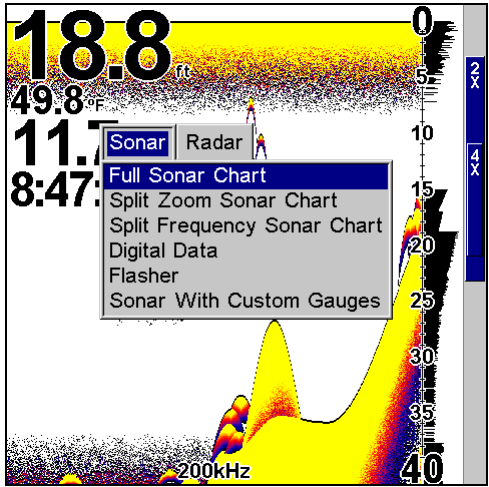

Pages Menu showing sonar chart display options. Split Frequency Sonar chart page is only available in the X-515cDF.

Full Sonar Chart

This is the default mode used when the unit is turned on for the first time or when it's reset to the factory defaults.

The bottom signal scrolls across the screen from right to left. Depth scales on the right side of the screen aid in determining the depth of targets. The line at the top of the screen represents the surface. The bottom depth and surface temperature (if equipped with a temperature sensor or a transducer with a temp sensor built in) show at the top left corner of the screen.

The FasTrack™ display is just to the right of the depth scale. This changes all echoes into short horizontal bars, replicating a flasher sonar. The zoom bar on the far right shows the area that's magnified when the zoom is in use. (See the Zoom section on page 86 for more information.)

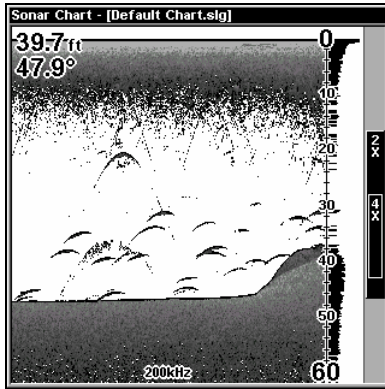

Full Sonar Chart. Overlay Data (depth and water temperature) is set to a small text size.

Split Zoom Sonar Chart

A split chart shows the underwater world from the surface to the bottom on the right side of the screen. The left side shows an enlarged version of the right side. The zoom range shows at the bottom left corner of the screen.

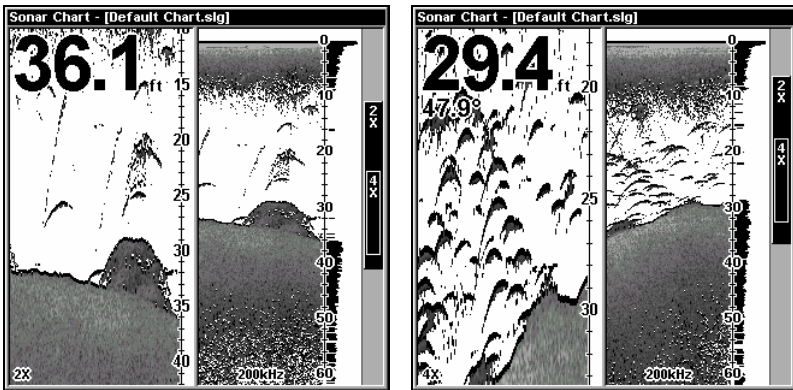

Split Zoom Sonar Chart image (left) shows the left window zoomed to 2X. The second image (right) shows the left window zoomed to 4X. The depth overlay data is set to the default large text size; the water temperature is set to the small text size.

Split Frequency Sonar Chart (X-515cDF only)

This page shows sonar data from the 50 kHz transducer on the left side of the screen and data from the 200 kHz transducer on the right side. All other functions and features are the same as the Full Chart page. You can adjust the sensitivity in each window.

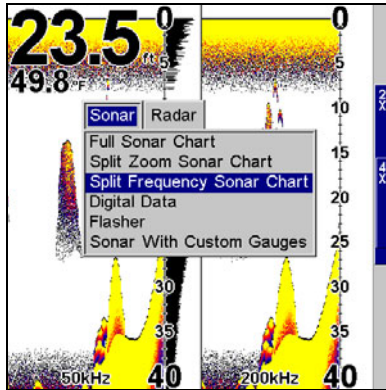

Split Frequency Sonar Chart page, with 50 kHz view on the left, 200 kHz view on the right.

To adjust sensitivity in auto mode

1. Press **MENU | ENT**.
2. The unit asks which you wish to adjust. Press ← or → to select the one you want | **ENT**.
3. The Sensitivity Control Bar appears. Press ↓ to decrease sensitivity; press ↑ to increase sensitivity. When it's set at the desired level, press **EXIT**. (When you reach the maximum or minimum limit, a tone sounds.)

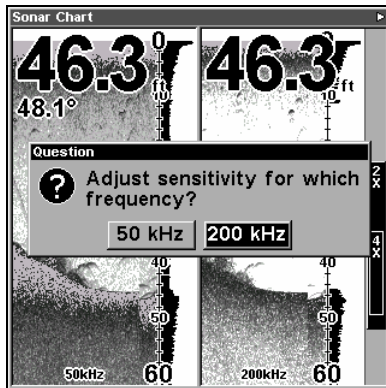

The Split Frequency Sonar Chart page allows you to adjust sensitivity separately for each window.

Digital Data/Chart

This mode shows the chart on the right side of the screen. The left side has five digital boxes containing: Depth; Water Speed (from an optional speed sensor); Water Distance (distance traveled or log – it also requires a speed sensor); Water Temperature and Voltage.

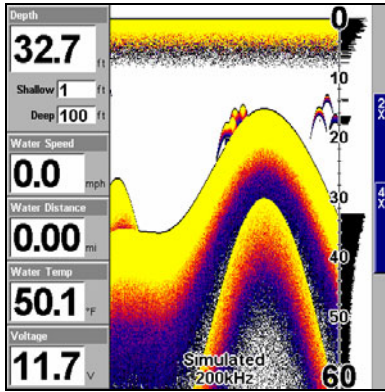

Digital Data/Chart

Customizing the Digital Data/Chart Screen

The Digital Data/Chart can be customized to show digital data in the order of your preference. To rearrange the data on this screen:

1. From the Digital Data Page, press **MENU** | **↓** to **CUSTOMIZE** | **ENT**.

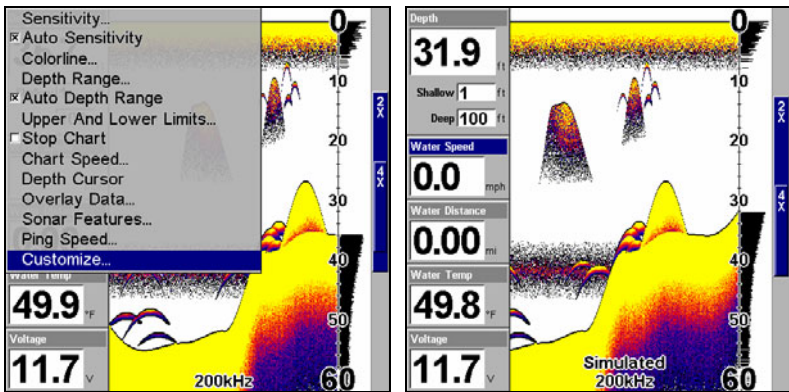

Customize command selected from the Sonar Page menu (left).
Selected W Speed box flashes black (right).

2. Use **↑** **↓** to select the digital data box you want to customize. The title bar for the selected box will flash indicating its contents can be changed. Press **ENT**, which will open the Data Viewer menu with three expandable categories: Time Sonar Data, Sensor Data.

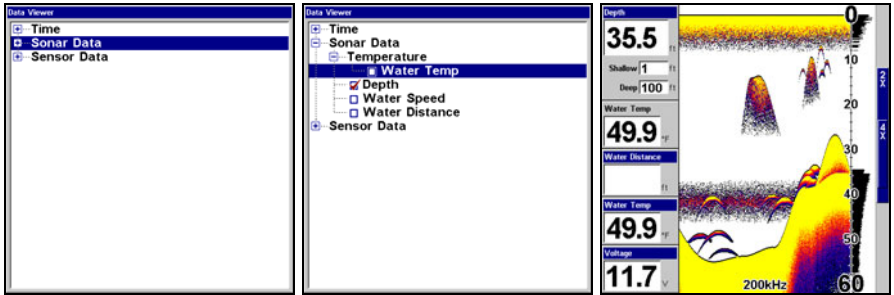

Data View menu (left). Sonar Data expanded with Water Temp Highlighted (center). Digital Data page (right) with Water Temp displayed.

3. Highlight the desired data category and press **ENT**, which will open its data menu.
4. Highlight the data for display and press **ENT** which will place a checkmark in its checkbox. Press **EXIT**.
5. The digital data box will display the data you selected. Repeat Step 2 to customize another data box or press **EXIT** to return to normal operation.

Flasher

The Flasher sonar page option represents a flasher style sonar combined with a scrolling chart. A circular dial shows all returning echoes at a high screen refresh rate.

It uses the Colorline feature to distinguish between strong and weak signals. For example, fish, one of the weakest echoes, shows up as a narrow blue line, while a hard bottom surface will be a thick yellow band. The bottom depth is shown as a black bar across the outer circle. There is also a narrow chart display on the left of the screen.

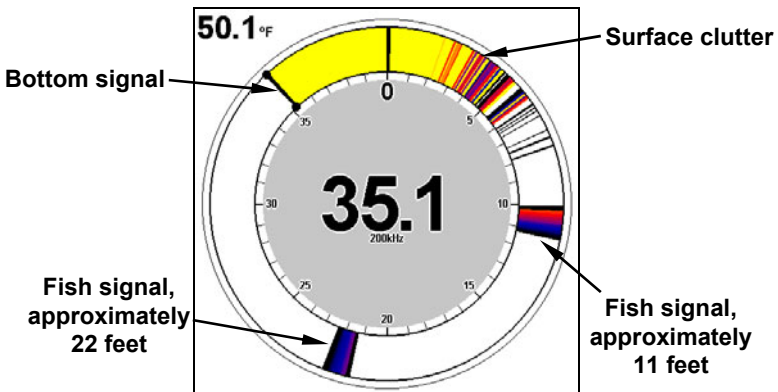

Flasher page.

Sonar with Custom Gauges

The Sonar with Custom Gauges page has a split screen with sonar on the right side, digital gauge information on the left side. The two windows can be resized to make one side bigger than the other or may be set up to split the screen evenly.

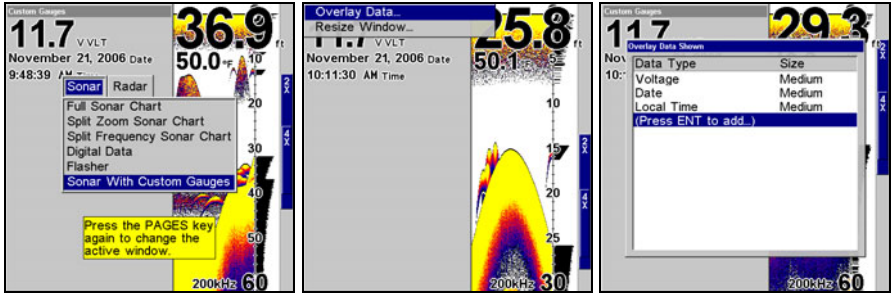

Sonar with Custom Gauges selected on the Pages menu (left). To change custom gauge information, access overlay data on the Custom Gauges menu (center). Overlay Data shown menu (right).

To customize digital gauge display:

1. Press **PAGES**, highlight **SONAR WITH CUSTOM GAUGES** and press **ENT**.
2. Press **MENU**, select **OVERLAY DATA** and press **ENT**. The Overlay Data shown menu will appear.
3. Highlight **(PRESS ENT TO ADD...)** and press **ENT** to open the Data Viewer menu with three expandable data categories: Time, Sonar Data and Sensor Data.
4. Highlight the desired data category and press **ENT**, which will expand the list, revealing several subcategories with checkboxes next to them.
5. Select the desired subcategory and press **ENT**, which will place a checkmark in the checkbox, showing the selected data is set for display.
6. If you want to display other data types, repeat Steps 4 and 5. Press **EXIT** repeatedly to get back to the Sonar with Custom Gauges page. The data you selected will now be displayed in the gray area on the left side of the screen.

To change Overlay data size:

1. After overlay data has been added to the display, press **PAGES**, highlight **SONAR WITH CUSTOM GAUGES** and press **ENT**. Press **MENU SELECT OVERLAY DATA** and press **ENT**. The Overlay Data Shown menu will appear.

2. Highlight the *Data Type* you want to resize, then use ← → to switch the data setting to one of the following four options: Off, Small, Medium, Large and Enormous.

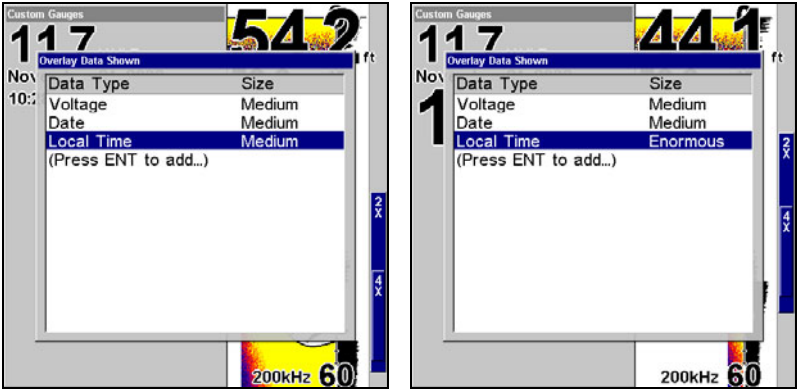

Local Time is set to medium size (left). The size of Local Time data has been changed to Enormous (right).

3. To change the size of another Data Type, repeat the steps above. To return to the Sonar with Custom Gauges display, press **EXIT**.

To resize Sonar and Custom Gauge windows:

1. From the Sonar with Custom Gauges page, press **MENU**, select **RESIZE WINDOW** and press **ENT**.
2. Use ← → to increase or decrease the size of each window. Press **EXIT**.

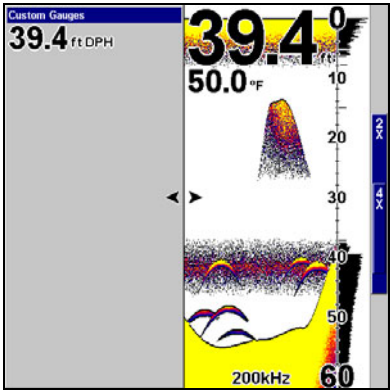

When the Resize Windows command is active, two arrows will appear between the two windows.

Radar

When you access the Radar Page, the screen will switch to the radar display. Information on radar installation and radar operation are included in two documents that come packed with Lowrance radar units: *Radar and RIM 100 Radar Interface Module Installation Instructions* and *Radar Operation Instruction Manual*. Refer to these documents for information on your radar unit.

NOTE:

Before using your radar, make sure you have checked the Enable Radar Port checkbox on the main menu.

To enable Radar Port:

1. From a sonar page, press **MENU | MENU** to access the main menu.
2. Highlight **ENABLE RADAR PORT** and press **ENT**, which will place an **X** in the Enable Radar Port checkbox.
3. Repeat Step 2 to disable the radar port, which will uncheck the checkbox. Press **EXIT** to return to the sonar display.

To access Radar Page:

1. Press **PAGES**, highlight the **RADAR** tab and press **ENT**.
2. Press **MENU** to open the Radar menu. Press **EXIT** to return to the radar display.

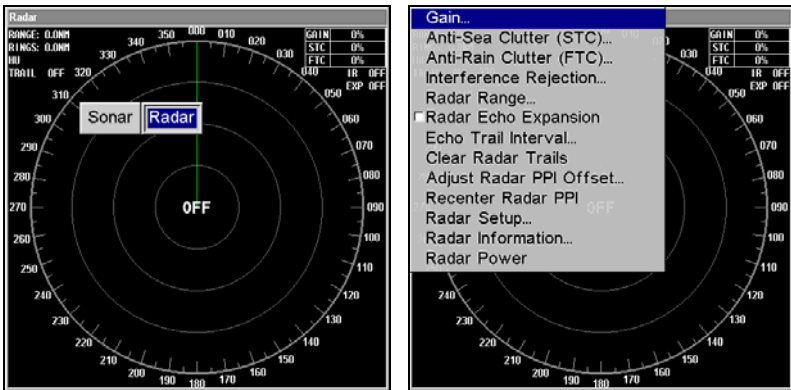

Radar Page (left) with Radar menu display (right).

Sonar Simulator

This unit has a built-in simulator that lets you run it as if you were on the water. All sonar features and functions are useable. When in simulator mode, you will see [Simulated] at the bottom of the display.

To use the simulator:

1. From a Sonar Page, press **MENU | MENU | ↓** to **SONAR SIMULATOR | ENT**.
2. Turn off the Sonar Simulator by pressing **MENU | MENU | ↓** to **SONAR SIMULATOR | ENT | EXIT**.

NOTE:

If you turn on your unit before attaching a transducer, it may enter a demo mode. The words "demo mode" flash on the bottom of the screen and a sonar chart plays much like the simulator. Unlike the simulator, the demo mode is for demonstration only, and will automatically stop as soon as you turn on the unit with a transducer attached. The simulator will continue to function normally.

Stop Chart

If you are running multiple units on a boat, there are times when you may want to turn off the sonar. This command turns off the sonar and stops the chart from scrolling. Sonar restarts automatically each time you turn on your unit.

To Stop Chart from running:

1. Press **MENU | ↓** to **STOP CHART | ENT | EXIT**.

To turn on sonar and start the chart scrolling again, repeat the above step.

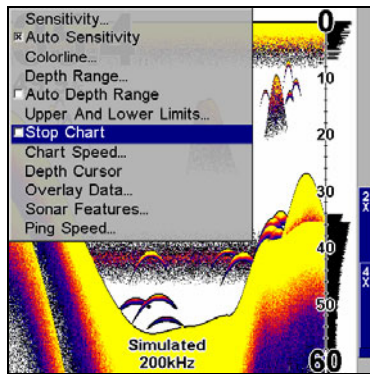

Sonar Menu with Stop Chart command selected. The box is unchecked, indicating the chart is scrolling across the screen.

Surface Clarity

The markings extending downward from the zero line on the chart are called "surface clutter." The clutter is caused by wave action, boat wakes, temperature inversion and more.

The surface clarity control reduces or eliminates surface clutter signals. It does this by changing the sensitivity of the receiver, decreasing it near the surface and gradually increasing it as the depth increases.

There are three levels of surface clarity available: low, medium, or high. It can also be turned off. The default level is off.

To adjust the Surface Clarity level

1. From the Sonar Page, press **MENU** | ↓ to **SONAR FEATURES** | **ENT**.
2. Press ↓ to **SURFACE CLARITY** | **ENT**.
3. Press ↓ or ↑ to select *clarity level* | **EXIT** | **EXIT** | **EXIT**.

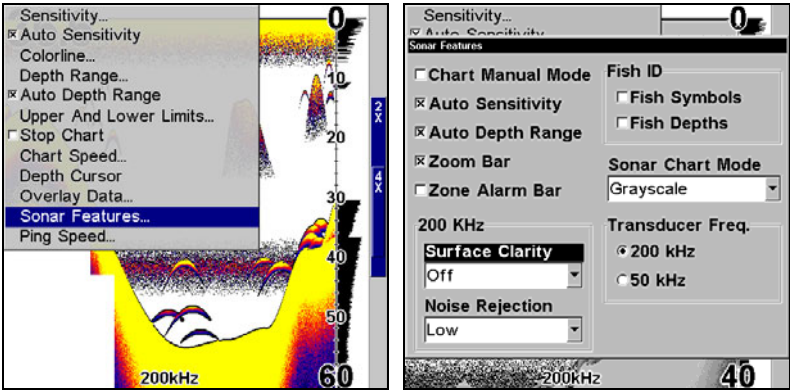

Sonar Features menu with Sonar Features selected (left). Surface Clarity highlighted on Sonar Features menu (right).

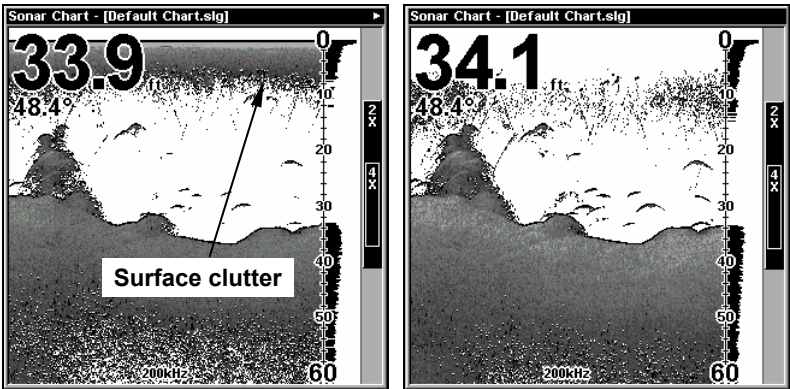

In the first illustration (left), Surface Clarity is turned off. The second example (right) Surface Clarity is set to High.

Transducer Type (X-515cDF only)

A dual-frequency unit includes a **TRANSDUCER TYPE** command. With this option you can tell your unit what type of transducer you're using, so it can properly interpret the signals it's receiving.

To change your transducer type:

1. Press **MENU | MENU | ↓** to **TRANSDUCER TYPE | ENT**.
2. Select the appropriate transducer type and press **ENT | EXIT | EXIT**.

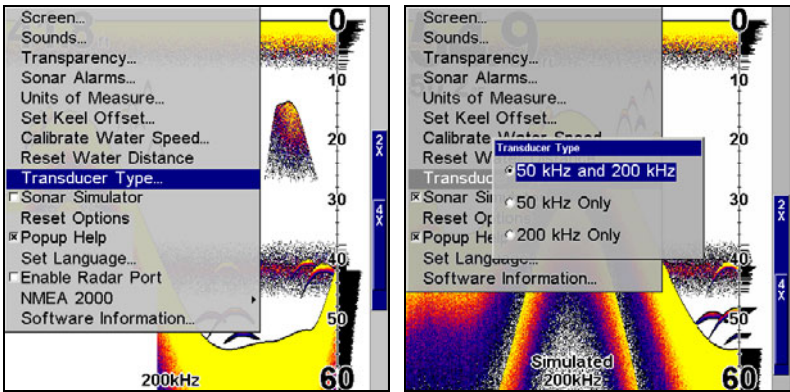

Main Menu with Transducer Type selected (left).
Transducer Type menu with three options (right).

Transparency

Use the transparency menu to adjust the transparency of menu windows. A high transparency allows you to continue monitoring the screen's display while adjusting feature settings, though the text of the menus may fade until it is unreadable. A low transparency will usually make menu text easier to read, at the cost of watching your display.

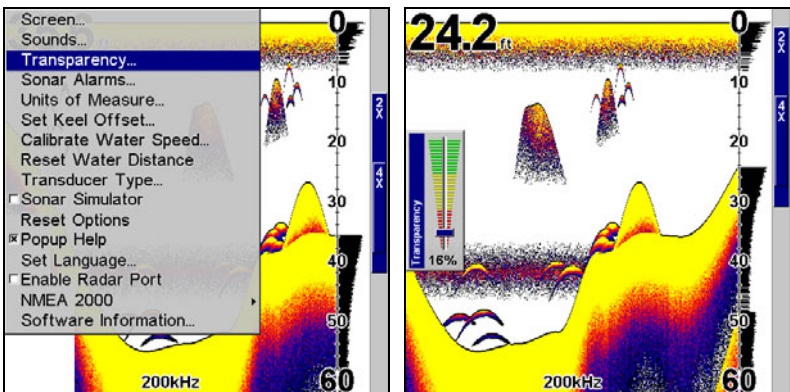

Main Menu with Transparency selected (left). Transparency control bar (right).

To adjust Transparency:

1. Press **MENU | MENU | ↓** to **TRANSPARENCY | ENT**. The **TRANSPARENCY** slider bar appears.
2. Press **↑ ↓** to adjust the level of transparency. Press **EXIT**.

Units of Measure

This menu sets the speed and distance (statute or nautical miles, meters), depth (feet, fathoms, or meters) and temperature (degrees Fahrenheit or Celsius). To change the units:

To set Speed/Distance:

1. Press **MENU | MENU**, highlight **UNITS OF MEASURE** and press **ENT**.
2. Speed/Distance will be highlighted. Press **ENT**.
3. Use **↑ ↓** to select one of the following options: Statute, Nautical or Metric. Press **ENT**.
4. Press **EXIT** repeatedly to return to the sonar display.

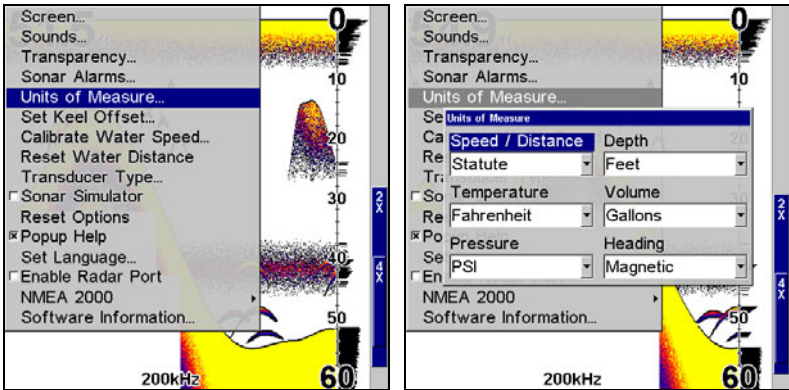

Units of Measure selected on main menu (left). Units of Measure Menu (right).

To set Temperature units:

1. Press **MENU | MENU**, highlight **UNITS OF MEASURE** and press **ENT**.
2. Highlight **TEMPERATURE** and press **ENT**.
3. Use **↑ ↓** to select one of the following options: Fahrenheit, Celsius or Kelvin. Press **ENT**.
4. Press **EXIT** repeatedly to return to the sonar display.

To set Pressure units:

1. Press **MENU | MENU**, highlight **UNITS OF MEASURE** and press **ENT**.
2. Highlight **PRESSURE** and press **ENT**.
3. Use **↑ ↓** to select one of the following options: Millibars, Bars, PSI, Hectopascals or Kilopascals. Press **ENT**.

4. Press **EXIT** repeatedly to return to the sonar display.

To set Depth units:

1. Press **MENU | MENU**, highlight **UNITS OF MEASURE** and press **ENT**.

2. Highlight **DEPTH** and press **ENT**.

3. Use **↑ ↓** to select one of the following options: Feet, Fathoms or Meters. Press **ENT**.

4. Press **EXIT** repeatedly to return to the sonar display.

To set Volume units:

1. Press **MENU | MENU**, highlight **UNITS OF MEASURE** and press **ENT**.

2. Highlight **VOLUME** and press **ENT**.

3. Use **↑ ↓** to select one of the following options: Gallons or Liters. Press **ENT**.

4. Press **EXIT** repeatedly to return to the sonar display.

To set Heading units:

1. Press **MENU | MENU**, highlight **UNITS OF MEASURE** and press **ENT**.

2. Highlight **HEADING** and press **ENT**.

3. Use **↑ ↓** to select one of the following options: True or Magnetic. Press **ENT**.

4. Press **EXIT** repeatedly to return to the sonar display.

Upper and Lower Limits

See the entry in this section for Depth Range - Upper and Lower Limits

Zoom & Zoom Bar

Zooming in the display is a common, fast and easy method used to enlarge small detail, fish signals and bottom structure. This unit lets you zoom in quickly and easily by pressing the Zoom In key, **ZIN**.

Pressing **ZIN** once doubles the size (2X) of all echoes on the screen. Pressing it again quadruples the size of the echoes (4X). The blue zoom bar on the far right side of the screen shows which echoes will be displayed on the screen when the **ZIN** key is pressed.

Pressing the **ZIN** key once will enable a 2X zoom which will show all echoes that are between the top and bottom of the 2X zoom bar. Pressing the key again will give a 4X zoom and only the echoes between the top and bottom of the 4X bar will be displayed.

Press the Zoom Out key, **ZOUT**, to return the display to the normal mode.

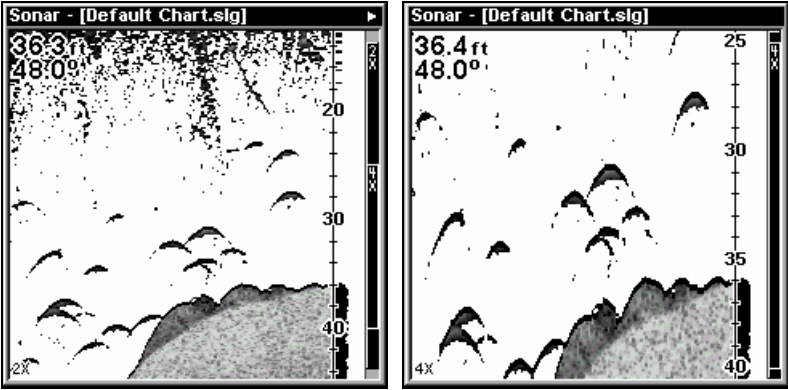

The first image (left) is a full sonar chart zoomed 2X. The second image (right) is the same view zoomed 4X.

Zoom Pan

Your unit has the handy ability to quickly zoom in on any portion of the water column with just the touch of an arrow key. The Zoom Pan feature lets you rapidly move the zoomed area up and down to different depths. By "pointing" your zoom at different portions of the chart as it scrolls, you can get a good, close-up look at structure or cover below you.

To use Zoom Pan, switch to a manual depth Range setting (see page 57) and turn on 2X or 4X Zoom. Then press \uparrow \downarrow to pan up and down the water column.

Notes

Section 5: NMEA 2000 Menu

NMEA 2000 Menu

The NMEA 2000 menu on your display unit's main menu allows you to configure, calibrate and monitor devices on your NMEA 2000 network. It provides access to the Bus Setup, Fuel Management and NMEA 2000 Alarms. You also can turn on/off Waypoint Sharing and Backlight Synchronization from the NMEA 2000 menu.

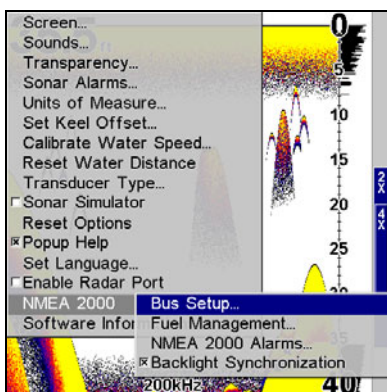

Bus Setup highlighted on the NMEA 2000 menu.

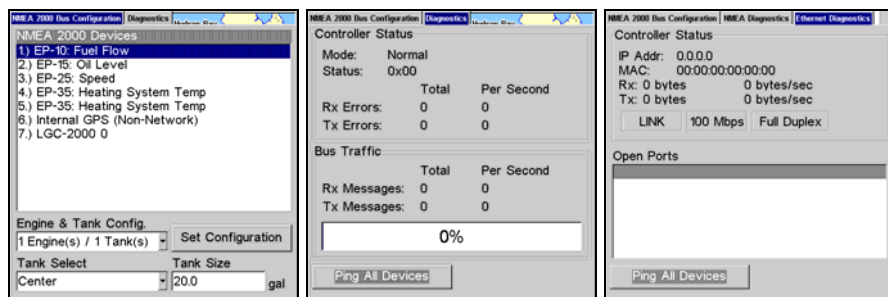

Bus Configuration menu (left). NMEA Diagnostics page (center). Ethernet Diagnostics (right)

Bus Setup

Selecting Bus Setup from the NMEA 2000 menu gives you access to the Bus Configuration menu and the NMEA Diagnostics and Ethernet Diagnostics pages. The Bus Configuration menu allows you to choose an engine-tank configuration and manage devices on the network. When the Bus Configuration menu is accessed, a list will appear of all NMEA 2000 devices on the network.

The NMEA Diagnostics page displays information about the performance of the network bus, keeping you updated on bus status, mode, errors and bus traffic.

The Ethernet Diagnostics page keeps you updated on the performance of an Ethernet connection (if applicable) supplying information ranging from IP Address to upload and download rates (bytes per second). To refresh either Diagnostics page, highlight the **PING ALL DEVICES** button at the bottom of the page and press **ENT**.

The network devices list is located in the top half of the Bus Configuration menu. You can configure, calibrate and set alarms for devices accessed from the Bus Configuration menu network devices list.

The Engine-Tank Configuration and Tank Select menus as well as the Tank Size dialog box are located on the bottom half of the Bus Configuration menu. The Set Configuration button — positioned next to the engine-tank configuration menu — allows you to finalize a selected configuration.

NOTE:

If you have not used the LMF-200 or LMF-400 to choose an engine-tank configuration for your vessel, you must use your display unit to select a configuration.

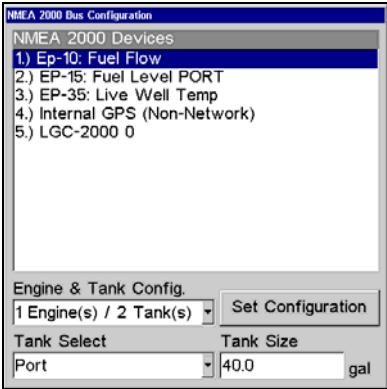

Bus Configuration menu with list of network devices. Engine-Tank Configuration and Tank Select menus are at the bottom of the screen.

Engine & Tank Configuration

The Engine-Tank configuration menu is located below the NMEA 2000 Devices list, but will only be accessible if a Suzuki engine Interface, EP-10 Fuel Flow, EP-15 Fluid Level, EP-45 Pressure Sensor or EP-50 Storage Device are on the network.

When choosing an engine-tank configuration you will use the Tank Select menu, Tank Size dialog box and Set configuration button, all detailed below.

Tank Select

The Tank Select menu allows you to choose from up to three tanks (Port, Center and Starboard), depending on the Engine-tank configuration that has been selected. This allows you to set up each tank individually.

Tank Size

The Tank Size menu allows you to input the size of a selected tank in gallons. After selecting the desired tank from the Tank Select menu, you are ready to enter the tank's size.

Set Configuration button

The Set Configuration button is used to finalize engine-tank configuration settings.

Setting Engine-Tank Configuration:

1. Press **MENU| MENU**, use $\downarrow \uparrow$ to highlight **NMEA 2000** and press **ENT**.
2. The NMEA 2000 menu will appear with five options: Bus Setup, Fuel Management, NMEA 2000 Alarms, Waypoint Sharing and Backlight Synchronization. Choose **BUS SETUP** and press **ENT**.
3. Select **ENGINE & TANK CONFIG** and press **ENT**, which will open the Engine & Tank Configuration menu with the following configuration options: 1 Engine/1 Tank, 1 Engine/2 Tanks, 2 Engines/1 Tank, 2 Engines/2 Tanks, 3 Engines/1 Tank, 3 Engine/3 Tanks and Unconfigured Bus.

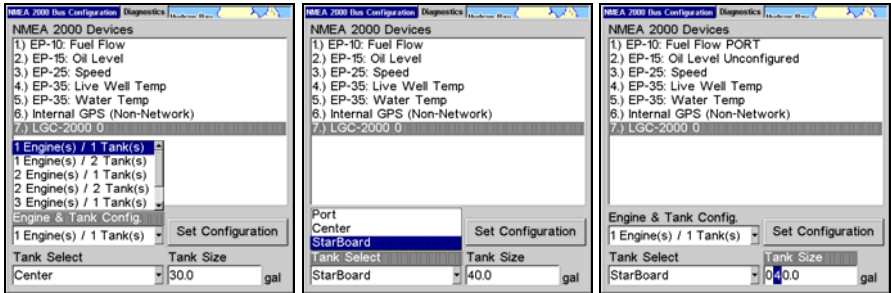

1 Engine/1Tank highlighted on Engine and Tank Configuration menu (left). Starboard highlighted on Tank Select menu (center). Tank Size set to 40 gallons (right).

4. Choose the configuration that matches the number of engines and tanks on your vessel and press **ENT**.
5. Highlight **TANK SELECT** and press **ENT**, which will open the Tank Select menu.

6. Select the tank you want to set up and press **ENT**. Press **→** to highlight the Tank Size dialog box and press **ENT**.
7. Use **↓**, **↑**, **←**, **→** to input the capacity (gallons) of the tank you chose from the Tank Select menu and press **ENT**.
8. Repeat Steps 5-7 for each remaining tank.
9. When all tanks have been configured, press the **SET CONFIGURATION** button. The following confirmation message will appear: *Are you sure you wish to change the bus configuration?* Choose **YES** and press **ENT**, Press **EXIT** to get back to the main display.

Device Configuration Menu

When a device is selected from the network devices list on the Bus Configuration menu, its Device Configuration menu will appear. Device configuration menus vary among devices. Available functions on device configuration menus allow you to change device names, tank sizes, fluid types and provide access to the Advanced Options menu. We will cover configuration and calibration later in this section.

Device Information and Device Data

The Device information panel, located to the left of the Device Configuration menu, displays information on the selected device that includes, software version, model, address, serial number, instance and current status.

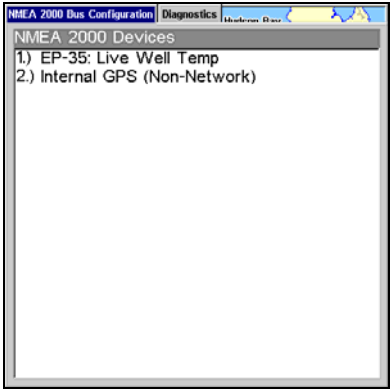

If you do not have an EP-15 Fluid Level, EP-10 Fuel Flow or EP-20 Engine Interface on the network, the Bus Configuration menu will not display the Engine-Tank Configuration menu, Tank Select menu, Tank Size menu or Set Configuration button.

Device Data is shown in the Device Data window at the bottom of the device configuration menu. The information displayed in the Device Data window will vary among devices. If, for example, you are viewing the device configuration menu for an EP-15 Fluid Level, the device

data window will include tank size and the amount of fuel left in the tank. The Device Data for an EP-10 Fuel Flow includes Fuel Rate (amount of fuel burned per hour), Fuel Used, Trip Fuel Used and Seasonal Fuel Used.

NOTE:

If, as in the graphic above, you do not have a Suzuki Engine Interface, EP-15 Fluid Level or EP-10 Fuel Flow on the network, the Engine & Configuration menu, Tank Select menu, Tank Size dialog and Set Configuration button will not be displayed on the Bus Configuration menu.

Fuel Management Menu

The Fuel Management menu gives you access to the following options: Tank Location, Fuel Added, Add Fuel, Fill Tank, Engine Select, Reset Calibration, Reset Trip and Reset Seasonal. Those options allow you to configure, calibrate, reset calibration, reset trip fuel and reset seasonal fuel for select NMEA 2000 devices. We will cover configuration and calibration procedures later in this section.

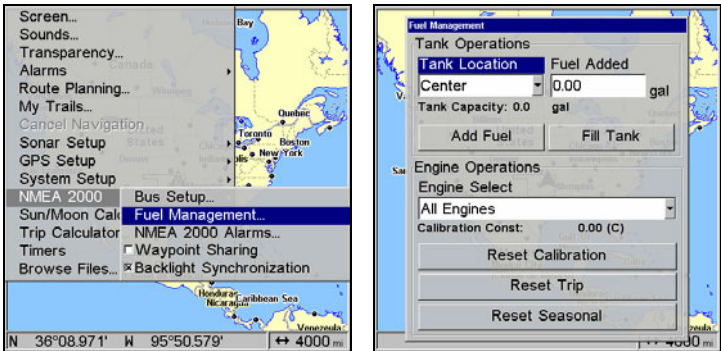

Fuel Management highlighted on the NMEA 2000 menu (left).
Fuel Management menu (right).

Tank Location

If you chose an engine-tank configuration with more than one tank, you will be able to switch the tank location (configuration) in the Tank Location menu. When fuel is added to a tank, you will select the correct tank from the Tank Location menu, then input the amount of fuel added in the Fuel Added dialog box.

Fuel Added

Used in tandem with the Add Fuel command, the Fuel Added dialog box allows you to input the amount of fuel added to the tank, when an amount of fuel is added that does not fill up the tank.

Add Fuel

After entering the amount of fuel added to a tank in the Fuel Added dialog, the Add Fuel command finalizes the entry of the data. Like the Fuel Added dialog, the Add Fuel command will only be used when an amount of fuel is added that does not fill the tank.

Fill Tank

You will use the Fill Tank command when calibrating a fuel flow and when filling up the tank without calibration.

Adding Fuel to Tank

Tank Location, Fuel Added and Add Fuel commands work together to keep NMEA 2000 fuel data consistent with the actual amount of fuel added to the fuel tank(s).

1. Press **MENU | MENU**, select **NMEA 2000** and press **ENT**.
2. The NMEA 2000 menu will appear with five options: Bus Setup, Fuel Management, NMEA 2000 Alarms, Waypoint Sharing and Backlight Synchronization. Select **FUEL MANAGEMENT** and press **ENT**.
3. Highlight **TANK LOCATION** and press **ENT**. The Tank Location menu will appear with up to three options: Port, Center and Starboard.
4. Select the tank you added fuel to and press **ENT**.
5. Follow the steps below that apply to your tank.

If you filled up the tank:

A. Press the **FILL TANK** button and press **ENT**. The following message will appear: *Are you sure you wish to Fill Tank?* Press **ENT**. Another message will appear: *Do you wish to re-calibrate the device?* Highlight **No** and press **ENT**.

If you did not fill up the tank:

B. Highlight **FUEL ADDED** and press **ENT** to access the **FUEL ADDED** dialog box. Use **↑ ↓ , ← →** to input the amount of fuel added to the tank and press **ENT**. Select the **ADD FUEL** button and press **ENT**. The following message will appear: *Are you sure you wish to Add Fuel?* Highlight **Yes** and press **ENT**.

6. Press **EXIT** repeatedly to get back to the main display.

Engine Operations

The lower half of the Fuel Management menu contains the following Engine Operation functions: Engine Select, Reset Calibration, Reset Trip and Reset Seasonal.

Engine Select

Engine Select allows you to choose the desired engine when resetting calibration, resetting trip fuel and resetting seasonal fuel.

To Reset Calibration:

Choosing the Reset Calibration command will switch fuel flow calibration settings back to factory defaults.

1. Press **MENU | MENU**, select **NMEA 2000** and press **ENT**.
2. Highlight **FUEL MANAGEMENT** and press **ENT**. The Fuel Management menu will appear.
3. Highlight to **ENGINE SELECT** and press **ENT**. Select the desired engine — the engine attached to the desired fuel flow — and press **ENT**.
4. Highlight **RESET CALIBRATION** and press **ENT**. The following confirmation message will appear: *Are you sure you wish to Reset Calibration?* Select **YES** and press **ENT**. Calibration settings for the selected fuel have been returned to factory defaults.

To Reset Trip:

The Reset Trip function allows you to reset to zero the running total of fuel used on a particular trip.

1. Press **MENU | MENU**, select **NMEA 2000** and press **ENT**.
2. Highlight **FUEL MANAGEMENT** and press **ENT**. The Fuel Management menu will appear.
3. Select **RESET TRIP** and press **ENT**. The following confirmation message will appear: *Are you sure you wish to Reset Trip?* Highlight **YES** and press **ENT**. The Trip Fuel Used figure has been reset to zero.

To Reset Seasonal:

Your unit can track fuel usage not only for trips, but also for entire seasons. The reset seasonal command allows you to reset to zero the running total of fuel used during a season.

1. Press **MENU | MENU**, select **NMEA 2000** and press **ENT**.
2. Highlight **FUEL MANAGEMENT** and press **ENT**. The Fuel Management menu will appear.
3. Select **RESET SEASONAL** and press **ENT**. The following confirmation message will appear: *Are you sure you wish to Reset Seasonal?* Highlight **YES** and press **ENT**. The Seasonal Fuel Used figure has been reset to zero.

NMEA 2000 Alarms

The NMEA 2000 Alarms menu allows you to set Full and Empty fuel alarms for the EP-10 Fuel Flow, EP-15 Fluid Level, EP-50 Storage Device and the Suzuki Engine Interface. The alarms may be set to a percentage (0-100%) of tank capacity.

The second tab at the top of the NMEA 2000 Alarms page is the Alarm Status Tab. When an alarm has been set for a device, the alarm and its current status will be shown on the Alarm Status window.

To view the Alarm Status window, highlight the Alarm Status tab and press **ENT**.

To set NMEA 2000 Alarm:

1. Press **MENU | MENU**, select **NMEA 2000** and press **ENT**.
2. Highlight **NMEA 2000 ALARMS** and press **ENT**.
3. Highlight **FLUID LEVEL DEVICE** and press **ENT**. Use **↑ ↓** to select the device you want to set an alarm for and press **ENT**.
4. Highlight the **ENABLED** box next to the desired alarm (Full Alarm or Empty Alarm) and press **ENT** to turn on the alarm.
5. To set the alarm percentage, press **→** to highlight **PERCENT** and press **ENT**.
6. Use **↑ ↓, ← →** to input the desired percentage and press **ENT**. Repeat Steps 3-4 to set the other alarm.
7. Highlight **SET CONFIGURATION** and press **ENT** to finalize alarm settings. Press **EXIT** repeatedly to get back to the main display.

NOTE:

To turn off (uncheck) an alarm, highlight its **ENABLED BOX** and press **ENTER**.

Waypoint Sharing

Waypoint Sharing allows you to share a waypoint from one display unit with display units across the network.

To turn on/off Waypoint Sharing:

1. Press **MENU | MENU**, select **NMEA 2000** and press **ENT**.
2. Highlight **WAYPOINT SHARING** and press **ENT** which will turn on/off waypoint sharing.
3. Press **EXIT** repeatedly to get return to the main display.

Backlight Synchronization

The Backlight Synchronization command will keep all display unit backlight levels consistent across the NMEA 2000 network. So, if you set the backlight level to 75% on one display unit, all other units on the network will automatically switch to the same setting.

To turn on/off Backlight Synchronization:

1. Press **MENU | MENU**, select **NMEA 2000** and press **ENT**.
2. Highlight **BACKLIGHT SYNCHRONIZATION** and press **ENT**, which will turn on/off Backlight Synchronization.
3. Press **EXIT** repeatedly to get back to the main display.

Configuring EP Sensors

All configurable devices are configured through their Device Configuration menus, which may be accessed through the network devices list on the Bus Configuration menu.

EP-35 Temperature Configuration

To input Device Name:

1. Press **MENU | MENU**, use **↑ ↓** to select **NMEA 2000** and press **ENT**. The NMEA 2000 menu will appear with five options: Bus Setup, Fuel Management, NMEA 2000 Alarms, Waypoint Sharing and Backlight Synchronization.
2. Highlight **BUS SETUP** and press **ENT**, which will open the Bus Configuration menu. A list of network devices will be at the top of the page.
3. Select the temp sensor you want to rename and press **ENT**. The Device Configuration menu will appear with the Device Name dialog box highlighted.
4. Press **ENT** and use **↑ ↓, ← →** to input the desired name for the temp sensor. Press **ENT**. Press **EXIT** repeatedly to get back to the main display.

To select Temp Type:

1. Press **MENU | MENU**, use **↑ ↓** to select **NMEA 2000** and press **ENT**. The NMEA 2000 menu will appear with five options: Bus Setup, Fuel Management, NMEA 2000 Alarms, Waypoint Sharing and Backlight Synchronization.
2. Highlight **BUS SETUP** and press **ENT**, which will open the Bus Configuration menu. A list of network devices will be at the top of the page.
3. Select the desired temp sensor and press **ENT**. The Device Configuration menu will appear.
4. Highlight **TEMP TYPE** and press **ENT**. The following list of Temp Types will appear: Water, Outside, Inside, Engine Room, Cabin, Live Well, Bait Well, Refrigeration, Heating System and Unknown.
5. Highlight the desired Temp Type and press **ENT**. The following confirmation message will appear: *Are you sure you wish to change this device's configuration?*
6. Highlight **YES** and press **ENT**. Press **EXIT** repeatedly to get back to the main display.

Advanced Options menu

The Temp sensor Advanced Options menu contains two categories: Instance and Restore Defaults.

Instance

The Instance command is intended for use *only* by experienced NMEA 2000 network technicians. Instance allows network technicians to resolve certain electronic probe conflicts. This is most likely to occur if the network includes LMF-200 or LMF-400 digital gauges, which support the display of fewer electronic probes than sonar unit. If you want to use your unit in a network including one of these digital gauges, you may need to consult customer service.

You should never need this command if you are connecting your unit to a network with similar display units and/or a series of electronic probes.

Restore Defaults

The Restore Defaults command allows you to reset an individual EP-35 Temp Sensor's settings to factory defaults. If, for example, you execute the Restore Defaults command from your Water Temp's Advanced Options menu, only the settings for the Water Temp will be reset to factory defaults. Other temps on the network will not be affected.

To restore default settings:

1. Press **MENU| MENU**, use $\uparrow \downarrow$ to select **NMEA 2000** and press **ENT**. The NMEA 2000 menu will appear with five options: Bus Setup, Fuel Management, NMEA 2000 Alarms, Waypoint Sharing and Backlight Synchronization.
2. Highlight **BUS SETUP** and press **ENT**, which will open the Bus Configuration menu. A list of network devices will be at the top of the page.
3. Select the desired temp sensor and press **ENT**. The Device Configuration menu will appear.
4. Highlight **ADVANCED OPTIONS** and press **ENT**.
5. Select **RESTORE DEFAULTS** and press **ENT**. The following message will appear: *Are you sure you wish to change this device's configuration?*
6. Highlight **YES** and press **ENT**. Press **EXIT** repeatedly to get back to the main display.

EP-10 Fuel Flow Configuration

To input Device Name:

1. Press **MENU| MENU**, use $\uparrow \downarrow$ to select **NMEA 2000** and press **ENT**. The NMEA 2000 menu will appear with five options: Bus Setup, Fuel Management, NMEA 2000 Alarms, Waypoint Sharing and Backlight Synchronization.
2. Highlight **BUS SETUP** and press **ENT**, which will open the Bus Configuration menu. A list of network devices will be at the top of the page.

3. Select the fuel flow you want to rename and press **ENT**. The Device Configuration menu will appear with the Device Name dialog box highlighted.

4. Press **ENTER** and use $\uparrow \downarrow$, $\leftarrow \rightarrow$ to input the desired name for the fuel flow. Press **ENT**. Press **EXIT** repeatedly to get back to the main display.

To select a Location:

1. Press **MENU| MENU**, use $\uparrow \downarrow$ to select **NMEA 2000** and press **ENT**. The NMEA 2000 menu will appear with five options: Bus Setup, Fuel Management, NMEA 2000 Alarms, Waypoint Sharing and Backlight Synchronization.

2. Highlight **Bus SETUP** and press **ENT**, which will open the Bus Configuration menu. A list of network devices will be at the top of the page.

3. Select the desired fuel flow and press **ENT**. The Device Configuration menu will appear.

4. Select **LOCATION** and press **ENT**, which will open the Location menu with following options: Port, Center, Starboard and Unknown.

5. Highlight the desired location and press **ENT**. The following message will appear: *Are you sure you wish to change this device's configuration?*

5. Select **YES** and press **ENT**. Press **EXIT** repeatedly to return to the main display.

Advanced Options menu

The Fuel Flow sensor Advanced Options menu contains two categories: Instance and Restore Defaults.

Instance

The Instance command is intended for use *only* by experienced NMEA 2000 network technicians. Instance allows network technicians to resolve certain electronic probe conflicts. This is most likely to occur if the network includes LMF-200 or LMF-400 digital gauges, which support the display of fewer electronic probes than your sonar unit.

If you want to use your unit in a network including one of these digital gauges, you may need to consult customer service.

You should never need this command if you are connecting your unit to a network with similar display units and/or a series of electronic probes.

Restore Defaults

The Restore Defaults command allows you to reset an individual EP-10 Fuel Flow Sensor's settings to factory defaults.

If, for example, you execute the Restore Defaults command from your Port Fuel Flow Advanced Options menu, only the settings for the Port Fuel Flow will be reset to factory defaults. Other fuel flows on the network will not be affected.

To restore default settings:

1. Press **MENU| MENU**, use $\uparrow \downarrow$ to select **NMEA 2000** and press **ENT**. The NMEA 2000 menu will appear with five options: Bus Setup, Fuel Management, NMEA 2000 Alarms, Waypoint Sharing and Backlight Synchronization.
2. Highlight **BUS SETUP** and press **ENT**, which will open the Bus Configuration menu. A list of network devices will be at the top of the page.
3. Use $\uparrow \downarrow$ to select the desired fuel flow and press **ENT**. The Device Configuration menu will appear.
4. Highlight **ADVANCED OPTIONS** and press **ENT**.
5. Select **RESTORE DEFAULTS** and press **ENT**. The following message will appear: *Are you sure you wish to change this device's configuration?*
6. Highlight **YES** and press **ENT**. Press **EXIT** repeatedly to get back to the main display.

EP-15 Fluid Level Configuration

To input Device Name:

1. Press **MENU| MENU**, use $\uparrow \downarrow$ to select **NMEA 2000** and press **ENT**. The NMEA 2000 menu will appear with five options: Bus Setup, Fuel Management, NMEA 2000 Alarms, Waypoint Sharing and Backlight Synchronization.
2. Highlight **BUS SETUP** and press **ENT**, which will open the Bus Configuration menu. A list of network devices will be at the top of the page.
3. Select a fluid level you want to rename and press **ENT**. The Device Configuration menu will appear with the Device Name dialog box highlighted.
4. Press **ENT** and use $\uparrow \downarrow, \leftarrow \rightarrow$ to input the desired name for the fluid level. Press **ENTER**. Press **EXIT** repeatedly to get back to the main display.

To select Tank Instance (Location):

1. Press **MENU| MENU**, use $\uparrow \downarrow$ to select **NMEA 2000** and press **ENT**. The NMEA 2000 menu will appear with five options: Bus Setup, Fuel Management, NMEA 2000 Alarms, Waypoint Sharing and Backlight Synchronization.
2. Highlight **BUS SETUP** and press **ENT**, which will open the Bus Configuration menu. A list of network devices will be at the top of the page.

3. Select the desired fluid level and press **ENT**. The Device Configuration menu will appear.
4. Highlight **TANK INSTANCE** and press **ENT**, which will open the Tank Instance menu with the following options: Tank 1, Tank 2, Tank 3 and Unknown.
5. Select the desired Tank Instance (location) and press **ENT**. The following confirmation message will appear: *Are you sure you wish to change this device's configuration?*
6. Highlight **YES** and press **ENT**. Press **EXIT** repeatedly to get back to the main display.

To select Fluid Type:

1. Press **MENU| MENU**, use $\uparrow \downarrow$ to select **NMEA 2000** and press **ENT**. The NMEA 2000 menu will appear with five options: Bus Setup, Fuel Management, NMEA 2000 Alarms, Waypoint Sharing and Backlight Synchronization.
2. Highlight **BUS SETUP** and press **ENT**, which will open the Bus Configuration menu. A list of network devices will be at the top of the page.
3. Select the desired fluid level and press **ENT**. The Fluid Level Device Configuration menu will appear.
4. Press \downarrow to **FLUID TYPE** and press **ENT**, which will open the Fluid Type menu with the following options: Fuel, Water, Gray Water, Live Well, Oil, Black Water and Unknown.
5. Select the desired fluid type and press **ENT**. The following message will appear: *Are you sure you wish to change this device's configuration?*
6. Highlight **YES** and press **ENT**. Press **EXIT** repeatedly to get back to the main display.

To input Tank Size:

1. Press **MENU| MENU**, use $\uparrow \downarrow$ to select **NMEA 2000** and press **ENT**. The NMEA 2000 menu will appear with five options: Bus Setup, Fuel Management, NMEA 2000 Alarms, Waypoint Sharing and Backlight Synchronization.
2. Highlight **BUS SETUP** and press **ENT**, which will open the Bus Configuration menu. A list of network devices will be at the top of the page.
3. Select the desired fluid level and press **ENT**. The Fluid Level Device Configuration menu will appear.
4. Highlight **TANK SIZE** and press **ENT**. Use $\uparrow \downarrow, \leftarrow \rightarrow$ to input the size of the tank and press Enter. The following message will appear: *Are you sure you wish to change this device's configuration?*
5. Select **YES** and press **ENT**. Press **EXIT** repeatedly to get back to the main display.

Advanced Options menu

The Fuel Flow sensor Advanced Options menu contains two categories: Instance and Restore Defaults.

Instance

The Instance command is intended for use *only* by experienced NMEA 2000 network technicians. Instance allows network technicians to resolve certain electronic probe conflicts. This is most likely to occur if the network includes LMF-200 or LMF-400 digital gauges, which support the display of fewer electronic probes than your sonar unit. If you want to use your unit in a network including one of these digital gauges, you may need to consult customer service.

You should never need this command if you are connecting your unit to a network with similar display units and/or a series of electronic probes.

Restore Defaults

The Restore Defaults command allows you to reset an individual EP-15 Fluid Level Sensor's settings to factory defaults. If, for example, you execute the Restore Defaults command from your Gray Water Fluid Level Advanced Options menu, only the settings for the Gray Water Fluid Level will be reset to factory defaults. Other fluid levels on the network will not be affected.

To restore default settings:

1. Press **MENU| MENU**, use **↑ ↓** to select **NMEA 2000** and press **ENT**. The NMEA 2000 menu will appear with five options: Bus Setup, Fuel Management, NMEA 2000 Alarms, Waypoint Sharing and Backlight Synchronization.
2. Highlight **BUS SETUP** and press **ENT**, which will open the Bus Configuration menu. A list of network devices will be at the top of the page.
3. Select the desired fluid level and press **ENT**. The Device Configuration menu will appear.
4. Highlight **ADVANCED OPTIONS** and press **ENT**.
5. Select **RESTORE DEFAULTS** and press **ENT**. The following message will appear: *Are you sure you wish to change this device's configuration?*
6. Highlight **YES** and press **ENT**. Press **EXIT** repeatedly to get back to the main display.

NOTE:

The Fluid Level Device Configuration menu also contains the Calibrate button, but we will address that later in the segment covering Calibration.

Suzuki Engine Interface Configuration

To input Device Name:

1. Press **MENU|MENU**, use $\uparrow \downarrow$ to select **NMEA 2000** and press **ENT**. The NMEA 2000 menu will appear with five options: Bus Setup, Fuel Management, NMEA 2000 Alarms, Waypoint Sharing and Backlight Synchronization.
2. Highlight **BUS SETUP** and press **ENT**, which will open the Bus Configuration menu. A list of network devices will be at the top of the page.
3. Use $\uparrow \downarrow$ to select the engine interface you want to rename and press **ENT**. The Device Configuration menu will appear with the Device Name dialog box highlighted.
4. Press **ENT** and use $\uparrow \downarrow, \leftarrow \rightarrow$ to input a name for the interface. Press **ENT**. Press **EXIT** repeatedly to return to the main display.

To select a Location:

1. Press **MENU|MENU**, use $\uparrow \downarrow$ to select **NMEA 2000** and press **ENT**. The NMEA 2000 menu will appear with five options: Bus Setup, Fuel Management, NMEA 2000 Alarms, Waypoint Sharing and Backlight Synchronization.
2. Highlight **BUS SETUP** and press **ENT**, which will open the Bus Configuration menu. A list of network devices will be at the top of the page.
3. Select the desired engine interface and press **ENT**. The Device Configuration menu will appear.
4. Highlight **LOCATION** and press **ENT**, which will open the Location menu with the following options: Port, Center, Starboard and Unknown.
5. Select the desired location and press **ENT**. The following confirmation message will appear: *Are you sure you wish to change this device's configuration?*
6. Press **ENT**. Press **EXIT** repeatedly to get back to the main display.

To select Engine Type:

1. Press **MENU|MENU**, use $\uparrow \downarrow$ to select **NMEA 2000** and press **ENT**. The NMEA 2000 menu will appear with five options: Bus Setup, Fuel Management, NMEA 2000 Alarms, Waypoint Sharing and Backlight Synchronization.
2. Highlight **BUS SETUP** and press **ENT**, which will open the Bus Configuration menu. A list of network devices will be at the top of the page.
3. Use $\uparrow \downarrow$ to select the desired engine interface and press **ENT**. The Device Configuration menu will appear.
4. Highlight **ENGINE TYPE** and press **ENT**, which will open the Engine Type menu with the following options: DF40, DF50, DF60, DF70, DF90/115, DF140, DF150, DF175, DF200/225, DF250 and DF300.

5. Select your engine type and press **ENT**. The following message will appear: *Are you sure you wish to change this device's configuration?*
6. Highlight **Yes** and press **ENT**. Press **EXIT** repeatedly to get back to the main display.

Advanced Options menu

The Engine Interface Advanced Options menu contains three categories: Instance, Restore Defaults and Reset Trim Calibration.

Instance

The Instance command is intended for use *only* by experienced NMEA 2000 network technicians. Instance allows network technicians to resolve certain electronic probe conflicts. This is most likely to occur if the network includes LMF-200 or LMF-400 digital gauges, which support the display of fewer electronic probes than your sonar unit. If you want to use your unit in a network including one of these digital gauges, you may need to consult customer service. You should never need this command if you are connecting your unit to a network with similar display units and/or a series of electronic probes.

Restore Defaults

The Restore Defaults command allows you to reset an individual engine interface's settings to factory defaults. If, for example, you execute the Restore Defaults command from your Port Engine Interface Advanced Options menu, only the settings for the Port Engine Interface will be reset to factory defaults. Other engine interfaces on the network will not be affected.

To restore default settings:

1. Press **MENU|MENU**, use **↑↓** to select **NMEA 2000** and press **ENT**. The NMEA 2000 menu will appear with five options: Bus Setup, Fuel Management, NMEA 2000 Alarms, Waypoint Sharing and Backlight Synchronization.
2. Highlight **BUS SETUP** and press **ENT**.
3. Use **↑↓** to select the desired fluid level and press **ENT**. The Device Configuration menu will appear.
4. Highlight **ADVANCED OPTIONS** and press **ENT**.
5. Select **RESTORE DEFAULTS** and press **ENT**. The following message will appear: *Are you sure you wish to change this device's configuration?*
6. Highlight **Yes** and press **ENT**. Press **EXIT** repeatedly to get back to the main display.

NOTE:

The Suzuki Engine Interface Device Configuration menu contains two Engine Trim calibration commands, which will be addressed in the next segment of this section, Calibrating EP Sensors.

Calibrating EP Sensors

The factory calibration settings for the EP-10 Fuel Flow, EP-15 Fluid Level and Suzuki Engine Interface should be adequate for the majority of applications, so calibration will not be necessary in most cases.

EP-10 Fuel Flow Calibration

The default calibration for the EP-10 Fuel Flow is adequate in most cases, but if Fuel Used readings are off by more than 3 percent, calibration is recommended.

To check fuel flow accuracy:

Select Fuel Used to be shown as Overlay Data on your unit's main display. Refer to the Overlay Data segment of this manual for instructions on how to select Fuel Used data as Overlay Data.

1. After selecting Fuel Used as overlay data, fill up your tank and press **MENU | MENU**.
2. Select **NMEA 2000** and press **ENT**.
3. Highlight **FUEL MANAGEMENT** and press **ENT**. Select **TANK LOCATION** and press **ENT**.
4. Use **↑ ↓** to select the location (Port, Center or Starboard) of the fuel flow you want to calibrate and press **ENT**.
5. Highlight **FILL TANK** and press **ENT**. The following confirmation message will appear: *Are you sure you wish to Fill Tank?*
6. Select **Yes** and press **ENT**. The following confirmation message will appear: *Do you wish to re-calibrate the device?*
7. Highlight **No** and press **ENT**.
8. Take your vessel out on the water and burn at least five gallons of fuel. **Be sure you run only ONE engine — the engine connected to your fuel flow.**
9. Fill up your tank again, noting how much fuel you added to the tank. Compare that number to the Fuel Used figure displayed on the page you customized. If the amount of fuel you added to the tank and the fuel used figure are off by more than 3 percent, we recommend the fuel flow be calibrated.

NOTE:

You must use the gauge's Fill Tank command when filling your fuel tank to keep the fuel flow updated with correct information on the amount of fuel in the tank.

To calibrate an EP-10 Fuel Flow:

10. If calibration is necessary, press **MENU | MENU**, select **NMEA 2000** and press **ENT**.
11. Highlight **FUEL MANAGEMENT** and press **ENT**.
12. Select **TANK LOCATION** and press **ENT** to choose the location of the tank connected to selected fuel flow. Press **ENT**.
13. Highlight **FILL TANK** and press **ENT**. The following message will appear: *Are you sure you wish to Fill Tank?* Select **YES** and press **ENT**.
14. The following message will appear: *Do you wish to re-calibrate the device?* Select **YES** and press **ENT**.
15. Repeat these steps for each EP-10 Fuel Flow you want to calibrate.

To Reset Calibration:

1. Press **MENU | MENU**, select **NMEA 2000** and press **ENT**.
2. Highlight **FUEL MANAGEMENT** and press **ENT**.
3. Highlight **ENGINE SELECT** and press **ENT**. The Engine Select menu will appear with up to four options: All Engines, Port, Center and Starboard. Selecting All Engines will reset calibration for all engines back to factory defaults.
4. Select All Engines or the engine connected to the desired device and press **ENT**.
5. Highlight **RESET CALIBRATION** and press **ENT**. The following message will appear: *Are you sure you wish to Reset Calibration?*
6. Highlight **YES** and press **ENT**. Press **EXIT** repeatedly to get back to the main display.

EP-15 Fluid Level Calibration

The default calibration for the EP-15 Fluid Level is just as accurate as standard fluid level gauges. If, however, the tank has an irregular shape or greater accuracy is needed, calibration is recommended. There are three calibration options: 2-Point, 3-Point and 5-Point.

2-Point Calibration

A 2-point calibration is best suited for rectangular or square-shaped tanks, where the capacity of the top half of the tank matches the capacity in the lower half of the tank. In a two-point calibration, you will set two points, one each for empty and full levels. You can begin calibration at either of the two points, but we recommend starting with an empty tank. You will fill the tank to complete calibration.

1. Press **MENU | MENU**, use **↓ ↑** to select **NMEA 2000** and press **ENT**.
2. Highlight **BUS SETUP** and press **ENT**, which will open the Bus Configuration menu. A list of network devices will be at the top of the page.

3. Select the EP-15 Fluid Level and press **ENT**.
4. Press **↓** to select **CALIBRATE** and press **ENT**. The Device Calibration menu will appear. Instructions on Calibration will be listed at the top of the menu.
5. Highlight **NUM Pts**, press **ENT** and select **2**. Press **ENT**.
6. Select **FLUID LEVEL**, press **ENT**, then select **EMPTY LEVEL** and press **ENT**.
7. Make sure the fuel tank is empty, highlight **CALIBRATE** and press **ENT**. The following message will appear: *Empty Level Calibration Completed*. Press **ENT**.
8. Fill up your tank, highlight **FLUID LEVEL** and press **ENT**.
9. Select **FULL LEVEL** and press **ENT**. Highlight **CALIBRATE** and press **ENT**.
10. The following message will appear: *Full level Calibration Completed*. Press **ENT**, then press **EXIT** repeatedly to get back to the main display.

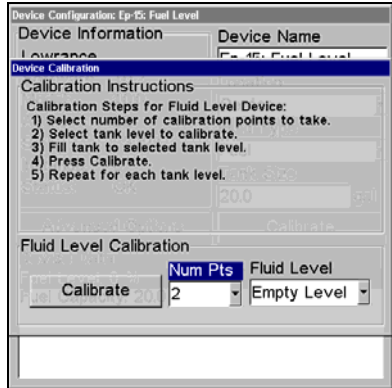

Calibrate is highlighted on the device configuration menu (left). Calibration menu (right) with calibration instructions listed at the top.

3-Point Calibration

3-point calibration is designed for tanks that vary in shape from the top to the bottom. You can begin calibration at any point in the 3-point process, but we recommend starting calibration with an empty tank.

In a 3-point calibration, you will set three points, one each for empty, half and full levels.

1. Press **MENU|MENU**, use **↓↑** to select **NMEA 2000** and press **ENT**.
2. Highlight **BUS SETUP** and press **ENT**, which will open the Bus Configuration menu. A list of network devices will be at the top of the page. 3. Select the EP-15 Fluid Level and press **ENT**.

4. Press **↓** to select **CALIBRATE** and press **ENT**. The Device Calibration menu will appear.
5. Highlight **NUM Pts**, press **ENT** and select **3**. Press **ENT**.
6. Make sure your tank is empty, then highlight **FLUID LEVEL** and press **ENT**. Select **EMPTY LEVEL** and press **ENT**.
7. Select **CALIBRATE** and press **ENT**. The following message will appear: *Empty Level Calibration Completed*. Press **ENTER**.
8. Add half a tank of fuel, highlight **FLUID LEVEL** and press **ENT**. Select **HALF LEVEL** and press **ENT**.
9. Select **CALIBRATE** and press **ENT**. The following message will appear: *Half Level Calibration Completed*. Press **ENT**.
10. Fill up the tank, then highlight **FLUID LEVEL** and press **ENT**. Select **FULL LEVEL** and press **ENT**.
11. Highlight **CALIBRATE** and press **ENT**. The following message will appear: *Full Level Calibration Completed*. Press **ENT**, then press **EXIT** repeatedly to get back to the main display.

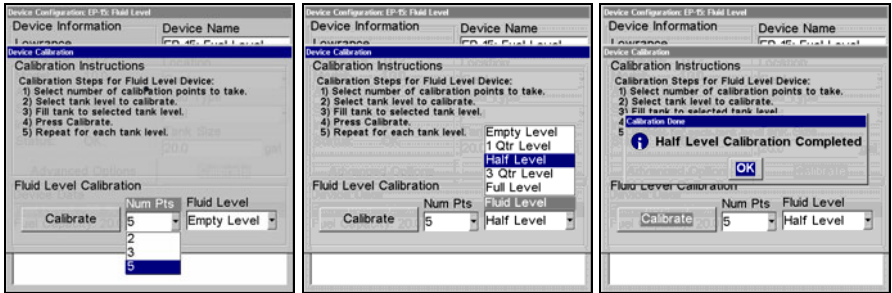

Num Pts menu with 5-point calibration selected (left). Half level selected on Fluid Level menu (center). Calibration Done window (right).

5-Point Calibration

5-point calibration is best suited tanks that vary greatly in shape from top to bottom. You can begin calibration at any point in the 5-point calibration process. We recommend starting calibration with an empty tank. In a five-point calibration you will set five points: Empty Level, 1 Qtr Level, Half Level, 3 Qtr Level and Full Level.

In a 5-point calibration, you will have four calibration points left after calibrating your tank's Empty Level. To figure out how much fuel you should add for the remaining steps of the calibration process, divide the total capacity of you tank by four. So, if you have a 40-gallon tank, each quarter tank will equate to 10 gallons.

1. Press **MENU|MENU**, use ↓↑ to select **NMEA 2000** and press **ENT**.
2. Highlight **BUS SETUP** and press **ENT**, which will open the Bus Configuration menu. A list of network devices will be at the top of the page.
3. Select the desired EP-15 Fluid Level and press **ENT**.
4. Press ↓ to select **CALIBRATE** and press **ENT**. The Device Calibration menu will appear.
5. Highlight **NUM PTS**, press **ENT** and select **5**. Press **ENT**.
6. Make sure your tank is empty, then highlight **FLUID LEVEL** and press **ENT**. Select **EMPTY LEVEL** and press **ENT**.
7. Select **CALIBRATE** and press **ENT**. The following message will appear: *Empty Level Calibration Completed*. Press **ENT**.
8. Add 1 quarter tank of fuel, highlight **FLUID LEVEL** and press **ENT**. Select **1 QTR LEVEL** and press **ENT**.
9. Select **CALIBRATE** and press **ENT**. The following message will appear: *1 Qtr Level Calibration Completed*. Press **ENT**.
10. Add another quarter tank of fuel, which should raise the fuel level to half a tank. Highlight **FLUID LEVEL** and press **ENT**. Select **HALF LEVEL** and press **ENT**.
11. Highlight **CALIBRATE** and press **ENT**. The following message will appear: *Half Level Calibration Completed*. Press **ENT**.
12. Add another quarter tank of fuel, which should raise the fuel level to 3 quarters of a tank. Highlight **FLUID LEVEL** and press **ENT**. Select **3 QTR LEVEL** and press **ENT**.
13. Select **CALIBRATE** and press **ENT**. The following message will appear: *3 Qtr Level Calibration Completed*. Press **ENT**.
14. Top off the tank, highlight **FLUID LEVEL** and press **ENT**. Select **FULL LEVEL** and press **ENT**.
15. Select **CALIBRATE** and press **ENT**. The following message will appear: *Full Level Calibration Completed*. Press **ENT**, then press **EXIT** repeatedly to get back to the main display.

Fuel Flow Calibration in a Suzuki Engine Interface

The default calibration for the Suzuki Engine Interface is adequate in most cases, but if Fuel Used readings are off by more than 3 percent, calibration is recommended.

To check engine interface accuracy:

Select Fuel Used to be shown as Overlay Data on your unit's main display. Refer to the Overlay Data segment of this manual for instructions on how to select Fuel Used data as Overlay Data.

1. After selecting Fuel Used as overlay data, fill up your tank and press **MENU | MENU**.
2. Select **NMEA 2000** and press **ENT**.
3. Highlight **FUEL MANAGEMENT** and press **ENT**. Select **TANK LOCATION** and press **ENT**.
4. Use **↑ ↓** to select the location (Port, Center or Starboard) of the engine interface you want to calibrate and press **ENT**.
5. Highlight **FILL TANK** and press **ENT**. The following confirmation message will appear: *Are you sure you wish to Fill Tank?*
6. Select **YES** and press **ENTER**. The following confirmation message will appear: *Do you wish to re-calibrate the device?*
7. Highlight **No** and press **ENT**. Take your vessel out on the water and burn at least five gallons of fuel. **Be sure you run only ONE engine — the engine connected to your engine interface.**
9. Fill up your tank again, noting how much fuel you added to the tank. Compare that number to the Fuel Used figure displayed on the page you customized. If the amount of fuel you added to the tank and the fuel used figure are off by more than 3 percent, we recommend the engine interface be calibrated.

NOTE:

You must use the gauge's Fill Tank command when filling your fuel tank to keep the engine interface updated with correct information on the amount of fuel in the tank.

To calibrate a Suzuki Engine Interface:

10. If calibration is necessary, press **MENU | MENU**, select **NMEA 2000** and press **ENT**.
11. Highlight **FUEL MANAGEMENT** and press **ENT**.
12. Select **TANK LOCATION** and press **ENT** to choose the location of the tank connected to the selected engine interface. Press **ENT**.
13. Highlight **FILL TANK** and press **ENT**. The following message will appear: *Are you sure you wish to Fill Tank?* Select **YES** and press **ENT**.
14. The following message will appear: *Do you wish to re-calibrate the device?* Select **YES** and press **ENT**.
15. Repeat these steps for each engine interface you want to calibrate.

Engine Trim Calibration

Engine Trim is calibrated through the Suzuki Engine Interface Device Configuration menu.

1. Press **MENU | MENU**, select **NMEA 2000** and press **ENT**.
2. Choose **BUS SETUP** and press **ENTER**. Select the Suzuki Engine Interface connected to the desired engine and press **ENT**.

3. Highlight **CALIBRATE TRIM** and press **ENT**. The Device Calibration window will appear with a list of Calibration Instructions.
4. Highlight **START CALIBRATION** and press **ENT**. The following message will appear: *Please fully raise the Engine Trim.*
5. After engine trim has been fully raised, press **ENT**. The following message will appear: *Please fully lower the Engine trim.*
6. After engine trim has been fully lowered, press **ENT**. A Calibration Completed message will appear. Press **ENT**.
7. Repeat these instructions to adjust the engine trim for each engine connected to a Suzuki Engine Interface. Press **EXIT** repeatedly to return to the main display.

Reset Trim Calibration

If you are not satisfied with your engine trim calibration, you can reset engine trim calibration from the Suzuki Engine Interface Advanced Options menu.

1. Press **MENU | MENU**, select **NMEA 2000** and press **ENT**.
2. Choose **BUS SETUP** and press **ENT**. Select the Suzuki Engine Interface connected to the desired engine and press **ENT**.
3. Highlight **ADVANCED OPTIONS** and press **ENT**. Select **Reset TRIM CALIBRATION** and press **ENT**. The following message will appear: *Do you wish to re-calibrate the device?*
4. Highlight **YES** and press **ENT**. Press **EXIT** repeatedly to get back to the main display.

Bennett Trim Tabs Calibration

Trim Tabs will be calibrated through their Device Configuration menu.

To calibrate Trim Tabs:

1. Press **MENU | MENU**, select **BUS SETUP** and press **ENT**. A list of network devices will appear.
2. Select **BENNETT TRIM TABS** from the list and press **ENT**, which will open the Trim Tab Device Configuration menu.
3. Highlight **CALIBRATE** and press **ENT**. The Device Calibration window will appear with a list of calibration instructions.
4. Select **START CALIBRATION** and press **ENT**. The following message will appear: *Please fully raise Trim Tabs.*
5. After fully raising the trim tabs, press **ENT**. The following message will appear: *Please fully lower trim tabs.*
6. After fully lowering the trim tabs, press **ENT**. A Calibration Complete message will appear. Press **ENT**. Press **EXIT** repeatedly to return to the main display.



Reset Calibration highlighted (left). Reset Calibration confirmation window (right).

To Reset Calibration:

1. Press **MENU | MENU**, select **NMEA 2000** and press **ENT**.
2. Highlight **FUEL MANAGEMENT** and press **ENT**.
3. Highlight **ENGINE SELECT** and press **ENT**. The Engine Select menu will appear with up to four options: All Engines, Port, Center and Starboard. Selecting All Engines will reset calibration for all engines back to factory defaults.
4. Select All Engines or the engine connected to the desired device and press **ENT**.
5. Highlight **RESET CALIBRATION** and press **ENT**. The following message will appear: *Are you sure you wish to Reset Calibration?*
6. Highlight **YES** and press **ENT**. Press **EXIT** repeatedly to get back to the main display.

Section 6:

Sonar Troubleshooting

If your unit is not working, or if you need technical help, please use the following troubleshooting section before contacting the factory customer service department. It may save you the trouble of returning your unit for repair. For contact information, refer to the last page, just inside the back cover of this manual.

Unit won't turn on

1. Check the power cable's connection at the unit. Also check the wiring.
2. Make sure the power cable is wired properly. The red wire connects to the positive battery terminal, black to negative or ground.
3. Check the fuse.
4. Measure the battery voltage at the unit's power connector. It should be at least 10 volts. If it isn't, the wiring to the unit is defective, the battery terminals or wiring on the terminals are corroded, or the battery needs charging.

Unit freezes, locks up, or operates erratically

1. Electrical noise from the boat's motor, trolling motor, or an accessory may be interfering with the sonar unit. Rerouting the power and transducer cables away from other electrical wiring on the boat may help. Route the sonar unit's power cable directly to the battery instead of through a fuse block or ignition switch.
2. Inspect the transducer cable for breaks, cuts, or pinched wires.
3. Check the transducer and power connector. Make sure it's securely plugged in to the unit.

Weak bottom echo, digital readings erratic, or no fish signals

1. Make sure the transducer is pointing straight down. Clean the face of the transducer. Oil, dirt and fuel can cause a film to form on the transducer, reducing its effectiveness. If the transducer is mounted inside the hull, be sure it is shooting through only one layer of fiberglass and that it is securely bonded to the hull. When attaching a transducer to the inside of a hull, **ONLY** use the epoxy available from LEI (order information is inside the back cover). Do **NOT** use RTV silicone rubber adhesive or any other type of epoxy. The LEI epoxy is specially formulated so that it will cure properly for shoot-through applications.

2. Electrical noise from the boat's motor can interfere with the sonar. This causes the sonar to automatically increase its discrimination or noise rejection feature. This can cause the unit to eliminate weaker signals such as fish or even structure from the display.

3. The water may be deeper than the sonar's ability to find the bottom. If the sonar can't find the bottom signal while it's in the automatic mode, the digital sonar display will flash continuously. It may change the range to limits far greater than the water you are in. If this happens, place the unit in the manual mode, then change the range to a realistic one, (for example, 0-100 feet) and increase the sensitivity. As you move into shallower water, a bottom signal should appear.

4. Check the battery voltage. If the voltage drops, the unit's transmitter power also drops, reducing its ability to find the bottom or targets.

Bottom echo disappears at high speeds or erratic digital reading or weak bottom echo while boat is moving

1. The transducer may be in turbulent water. It must be mounted in a smooth flow of water in order for the sonar to work at all boat speeds. Air bubbles in the water disrupt the sonar signals, interfering with its ability to find the bottom or other targets. The technical term for this is cavitation.

2. Electrical noise from the boat's motor can interfere with the sonar. This causes the sonar to automatically increase its discrimination or noise rejection feature. This can cause the unit to eliminate weaker signals such as fish or even structure from the display. Try using resistor spark plugs or routing the sonar unit's power and transducer cables away from other electrical wiring on the boat.

No fish arches when the Fish I.D. feature is off

1. Make sure the transducer is pointing straight down. This is the most common problem if a partial arch is displayed.

2. The sensitivity may not be high enough. In order for the unit to display a fish arch, it has to be able to receive the fish's echo from the time it enters the cone until it leaves. If the sensitivity is not high enough, the unit shows the fish only when it is in the center of the cone.

3. Use the Zoom feature. It is much easier to display fish arches when zoomed in on a small range of water than a large one. For example, you will have much better luck seeing fish arches with a 30 to 60 foot range than a 0 to 60 foot range. This enlarges the targets, allowing the display to show much more detail.

4. The boat must be moving at a slow trolling speed to see fish arches. If the boat is motionless, fish stay in the cone, showing on the screen as straight horizontal lines.

NOISE

A major cause of sonar problems is electrical noise. This usually appears on the sonar's display as random patterns of dots or lines. In severe cases, it can completely cover the screen with black dots, or cause the unit to operate erratically, or not at all.

To eliminate or minimize the effects of electrical noise, first try to determine the cause. With the boat at rest in the water, the first thing you should do is turn all electrical equipment on the boat off. Make sure the engine is also off. Turn your sonar on, then turn off Noise Reject [also known as the ASP feature (Advanced Signal Processing)]. Sensitivity should be set at 90-95 percent. There should be a steady bottom signal on the display. Now turn on each piece of electrical equipment on the boat and view the effect on the sonar's display. For example, turn on the bilge pump and view the sonar display for noise. If no noise is present, turn the pump off, then turn on the VHF radio and transmit. Keep doing this until all electrical equipment has been turned on, their effect on the sonar display noted, then turned off.

If you find noise interference from an electrical instrument, trolling motor, pump, or radio, try to isolate the problem. You can usually re-route the sonar unit's power cable and transducer cable away from the wiring that is causing the interference. VHF radio antenna cables radiate noise when transmitting, so be sure to keep the sonar's wires away from it. You may need to route the sonar unit's power cable directly to the battery to isolate it from other wiring on the boat.

If no noise displays on the sonar unit from electrical equipment, then make sure everything except the sonar unit is turned off, then start the engine. Increase the RPM with the gearshift in neutral. If noise appears on the display, the problem could be one of three things; spark plugs, alternator, or tachometer wiring. Try using resistor spark plugs, alternator filters, or routing the sonar unit's power cable away from engine wiring. Again, routing the power cable directly to the battery helps eliminate noise problems. Make sure to use the in-line fuse supplied with the unit when wiring the power cable to the battery.

When no noise appears on the sonar unit after all of the above tests, then the noise source is probably cavitation. Many novices or persons with limited experience make hasty sonar installations which function perfectly in shallow water, or when the boat is at rest. In nearly all cases, the cause of the malfunction will be the location and/or angle of the transducer. The face of the transducer must be placed in a location that has a smooth flow of water at all boat speeds. Read your transducer owner's manual or the Installation instructions (Sec. 2) in this manual for the best mounting position.

Notes

Notes

Notes

LOWRANCE ELECTRONICS FULL ONE-YEAR WARRANTY

"We," "our," or "us" refers to LOWRANCE ELECTRONICS, INC., the manufacturer of this product. "You" or "your" refers to the first person who purchases this product as a consumer item for personal, family or household use.

We warrant this product against defects or malfunctions in materials and workmanship, and against failure to conform to this product's written specifications, all for one (1) year from the date of original purchase by you. WE MAKE NO OTHER EXPRESS WARRANTY OR REPRESENTATION OF ANY KIND WHATSOEVER CONCERNING THIS PRODUCT. Your remedies under this warranty will be available so long as you can show in a reasonable manner that any defect or malfunction in materials or workmanship, or any non-conformity with the product's written specifications, occurred within one year from the date of your original purchase, which must be substantiated by a dated sales receipt or sales slip. Any such defect, malfunction, or non-conformity which occurs within one year from your original purchase date will either be repaired without charge or be replaced with a new product identical or reasonably equivalent to this product, at our option, within a reasonable time after our receipt of the product. If such defect, malfunction, or non-conformity remains after a reasonable number of attempts to repair by us, you may elect to obtain without charge a replacement of the product or a refund for the product. THIS REPAIR, OR REPLACEMENT OR REFUND (AS JUST DESCRIBED) IS THE EXCLUSIVE REMEDY AVAILABLE TO YOU AGAINST US FOR ANY DEFECT, MALFUNCTION, OR NON-CONFORMITY CONCERNING THE PRODUCT OR FOR ANY LOSS OR DAMAGE RESULTING FROM ANY OTHER CAUSE WHATSOEVER. WE WILL NOT UNDER ANY CIRCUMSTANCES BE LIABLE TO ANYONE FOR ANY SPECIAL, CONSEQUENTIAL, INCIDENTAL, OR OTHER INDIRECT DAMAGE OF ANY KIND.

Some states do not allow the exclusion or limitation of incidental or consequential damages, so the above limitations or exclusions may not apply to you.

This warranty does NOT apply in the following circumstances: (1) when the product has been serviced or repaired by anyone other than us; (2) when the product has been connected, installed, combined, altered, adjusted, or handled in a manner other than according to the instructions furnished with the product; (3) when any serial number has been effaced, altered, or removed; or (4) when any defect, problem, loss, or damage has resulted from any accident, misuse, negligence, or carelessness, or from any failure to provide reasonable and necessary maintenance in accordance with the instructions of the owner's manual for the product.

We reserve the right to make changes or improvements in our products from time to time without incurring the obligation to install such improvements or changes on equipment or items previously manufactured.

This warranty gives you specific legal rights and you may also have other rights which may vary from state to state.

REMINDER: You must retain the sales slip or sales receipt proving the date of your original purchase in case warranty service is ever required.

**LOWRANCE ELECTRONICS
12000 E. SKELLY DRIVE, TULSA, OK 74128
(800) 324-1356**

How to Obtain Service...

...in the USA:

We back your investment in quality products with quick, expert service and genuine Lowrance parts. If you're in the United States and you have technical, return or repair questions, please contact the Factory Customer Service Department. Before any product can be returned, you must call customer service to determine if a return is necessary. Many times, customer service can resolve your problem over the phone without sending your product to the factory. To call us, use the following toll-free number:

800-324-1356

8 a.m. to 5 p.m. Central Standard Time, M-F

Lowrance Electronics may find it necessary to change or end our shipping policies, regulations, and special offers at any time. We reserve the right to do so without notice.

...in Canada:

If you're in Canada and you have technical, return or repair questions, please contact the Factory Customer Service Department. Before any product can be returned, you must call customer service to determine if a return is necessary. Many times, customer service can resolve your problem over the phone without sending your product to the factory. To call us, use the following toll-free number:

800-661-3983

905-629-1614 (not toll-free)

8 a.m. to 5 p.m. Eastern Standard Time, M-F

...outside Canada and the USA:

If you have technical, return or repair questions, contact the dealer in the country where you purchased your unit. To locate a dealer near you, visit our web site, www.lowrance.com and look for the Dealer Locator.

Accessory Ordering Information for all countries

To order Lowrance accessories such as power cables or MMC cards, please contact:

1) Your local marine dealer, sporting goods or consumer electronics store. Most quality dealers that handle marine electronic equipment or other consumer electronics should be able to assist you with these items.

To locate a Lowrance dealer near you, visit our web site, www.lowrance.com and click on Support and then click Dealer Locator. Or, you can consult your telephone directory for listings.

2) U.S. customers: LEI Extras Inc., PO Box 129, Catoosa, OK 74015-0129
Call 1-800-324-0045 or visit our web site www.lei-extras.com.

3) Canadian customers can write:

Lowrance/Eagle Canada, 919 Matheson Blvd. E. Mississauga, Ontario L4W2R7 or fax 905-629-3118.

Shipping Information

If it becomes necessary to send a product for repair or replacement, you must first receive a return authorization number from Customer Service. Products shipped without a return authorization will not be accepted. When shipping, we recommend you do the following:

1. Please do not ship knobs or mounting brackets with gimbal units.
2. If your unit saves sonar logs or GPS data files to memory cards, make sure you have saved the data to a memory card and that the card has been removed from the unit, otherwise your data will be lost.
3. If you are sending a check for repair, please place your check in an envelope and tape it to the unit.
4. For proper testing, include a brief note with the product describing the problem. Be sure to include your name, return shipping address and a daytime telephone number. An e-mail address is optional but useful.
5. Pack the unit in a suitable size box with packing material to prevent any damage during shipping.
6. Write the Return Authorization (RA) number on the outside of the box underneath your return address.
7. For your security, you may want to insure the package through your shipping courier. Lowrance does not assume responsibility for goods lost or damaged in transit.



Visit our web site:



Lowrance Pub. 988-0151-451

Printed in USA 120406

© Copyright 2006
All Rights Reserved
Lowrance Electronics, Inc.